

APPENDIX A

Total Maximum Daily Loads of Nitrogen and Phosphorus for the Corsica River, Queen Anne's County, Maryland

Report Version: March, 2000

STUDY AREA

The Corsica River, a tributary of the Chester River, is located in Queen Anne's County, Maryland. The River is approximately 6 miles in length (refer Figure A1). The watershed of the Corsica River has an area of approximately 25,000 acres or 40 square miles. The predominant land use in the watershed, based on 1994 Maryland Office of Planning information is agricultural (15,600 acres or 62%), with other areas being under forest (6,700 acres or 27%), urban (1,400 acres or 5%) use, and open water (1,400 acres or 6%). For complete details of land use drainage areas refer figure A1. The upper free-flowing portion of the Corsica River traverses primarily agricultural lands, with some forested areas. The Town of Centreville, county seat of Queen Anne's County, is located at the head of tide. The lower, tidal portion enters the Chester River near Town Point in the oligohaline salinity zone. Much of the shoreline of the Corsica River's tidal portion is classified as agricultural, with scattered forested areas and coastal shallow fresh marsh. Depths of the river range from 1-2 feet in the headwaters to greater than 15 feet in the tidal zone prior to the river's confluence with the Chester River.

In the Corsica River watershed the total nutrient load coming from nonpoint source is total nitrogen load of 268,211 lb/yr, and the total phosphorus load of 19,380 lb/yr. Complete details of analysis of these loads is given in the Appendix. The existing nonpoint source loads were determined using a land use loading coefficient approach. The Corsica River Basin was digitized and overlaid onto a land use map using ARC/INFO GIS. The land use map was based on 1994 Maryland Office of Planning data. Next, the total nonpoint source load was calculated summing all of the individual land use areas multiplied by the corresponding land use loading coefficients. The loading rates were based on the results of the Chesapeake Bay Model (U.S. EPA, 1991), which was a continuous simulation model. The Chesapeake Bay Program nutrient loading rates account for atmospheric deposition, loads from septic tanks, and loads coming from urban development, agriculture, and forest land.

The point source flows came from the discharge monitoring reports stored in MDE's point source database.

WATER QUALITY CHARACTERIZATION

The water quality of four physical parameters, chlorophyll-a, inorganic phosphorus, total nitrogen, and dissolved oxygen, were examined to determine the extent of the impairment in the Corsica River. Two water quality surveys were conducted in the Corsica River watershed in the summer of 1997. Table A1 indicates the field and laboratory protocols. Figure A2 identifies the locations of the water chemistry sites sampled during each survey. Table A2 indicates the distance of these stations from the mouth of the Corsica River. The summer represents critical conditions for the Corsica River. This is because there is less water flowing in the channel, higher concentrations of nutrients, and the water temperatures are usually warmer creating good conditions for algal growth. The water quality data from 1997 was used because it was comprehensive. Previous intensive surveys conducted in 1992 and 1993 concentrated on the headwaters areas near the current Centreville Wastewater Treatment Plant discharge point, and extended down only to the Watson Road Bridge (Station COR0056). This location is not far enough downstream in the Corsica River to be useful for determining a TMDL for the entire Corsica River basin. Figures A3 through A6 show the longitudinal profile of chlorophyll-a, inorganic phosphorus, total nitrogen, and dissolved oxygen data.

Corsica River Watershed Land Use

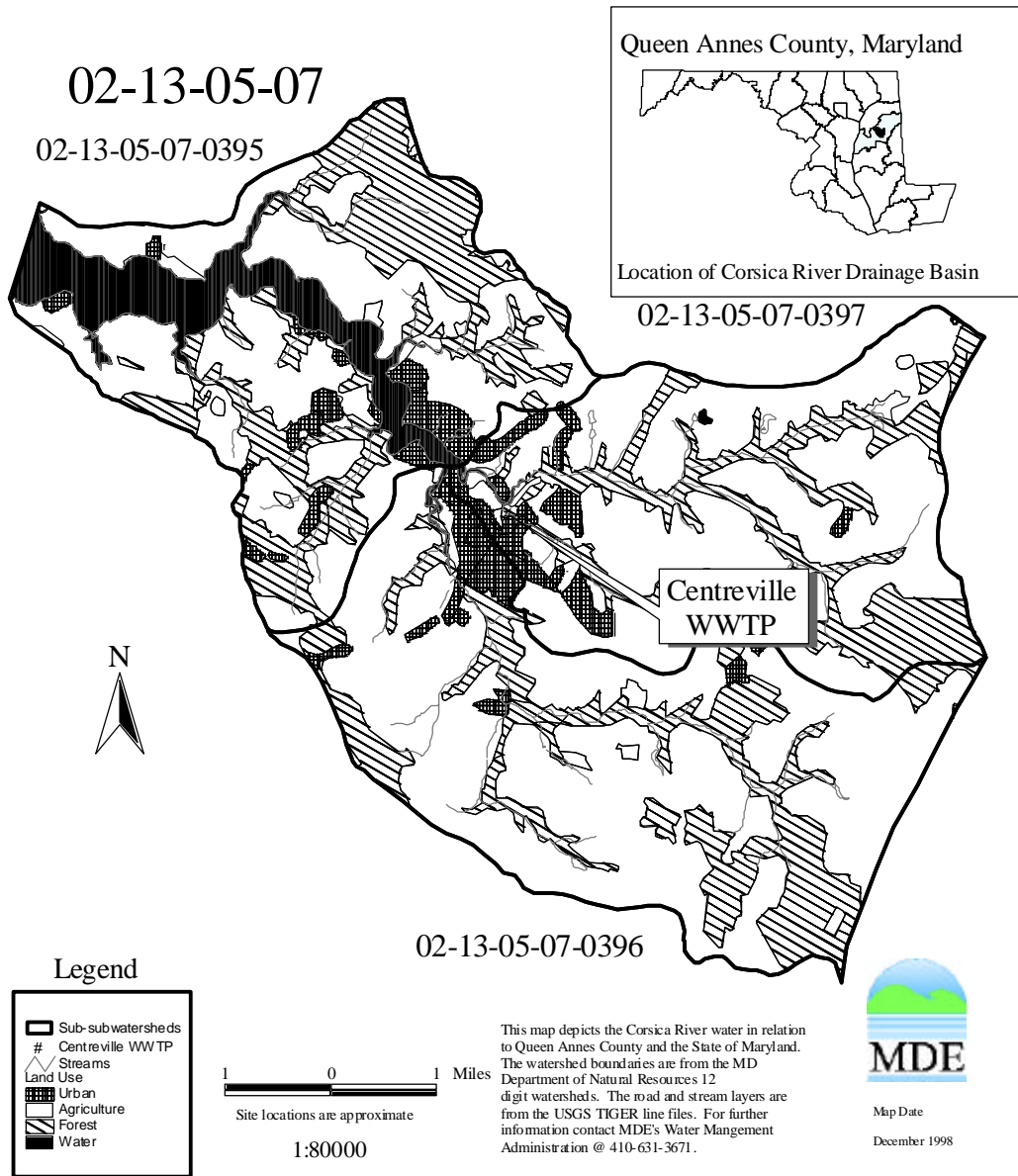

Figure A1: Corsica River Watershed Land Use

Table A1: Field and Laboratory Protocols

Parameter (units)	Detection Limits	Method Reference
IN SITU:		
Flow	0.01 cfs	Meter (Marsh-McBirney or Pygmy Sampler)
Temperature	-5 deg. C	Linear thermistor network; Hydrolab System 8000 Water Quality Instrumentation Manual (1978) (HSWQIM)
Dissolved Oxygen (ppm)	0 ppm	Au/Ag polarographic cell (Clark); HSWQIM
Conductivity (mmhos/cm)	0 mmhos/cm	Temperature-compensated, four electrode cell; HSWQIM
pH	1 pH	Glass electrode: Ag/AgCl reference electrode pair HSWQIM
Secchi Depth	0.1 m	20.3 cm disk
GRAB SAMPLES:		
Total Alkalinity	0.01 mg/l	Filtration ** EPA No. 310
Total Organic Carbon (mg/l as C)	1 mg/l	Adapted from **EPA method No. 425.2
Turbidity	0.1 FTU	Light scatter **EPA No. 1979
Total Suspended Solids	1mg/l	Standard Methods for the Examination of Water and Wastewater (15th ed.) sect. 209D, p. 94
Total Kjeldahl Nitrogen unfiltered (mg/l as N)	0.2 mg/l	Technicon Industrial Method # 376-75W/b; #329- 74W/B
Ammonia (mg/l as N)	0.004 mg/l	Technicon Industrial Method # 154-71W/B
Nitrate (mg/l as N)	0.0002 mg/l	Technicon Industrial Method # 154-71W/B2
Nitrite (mg/l as N)	0.0002 mg/l	Technicon Industrial Method # 102-70W/C
Total Phosphorus	0.001 mg/l	Technicon Industrial Method # 376-75W/B; #329- 74W/B
Ortho-phosphate (mg/l as P)	0.0006 mg/l	Technicon Industrial Method # 155-71W
Chlorophyll a	1 mg/cu. M	Standard Methods for the Examination of Water and Wastewater (15th ed.) #1002G. Chlorophyll. Pp 950-954.
BOD5	0.01 mg/l	Oxidation ** EPA No. 405

** EPA Chemical Analysis for Water and Wastes (March, 1979). EPA-600/79-020

Corsica River Watershed Water Chemistry Sites

02-13-05-07

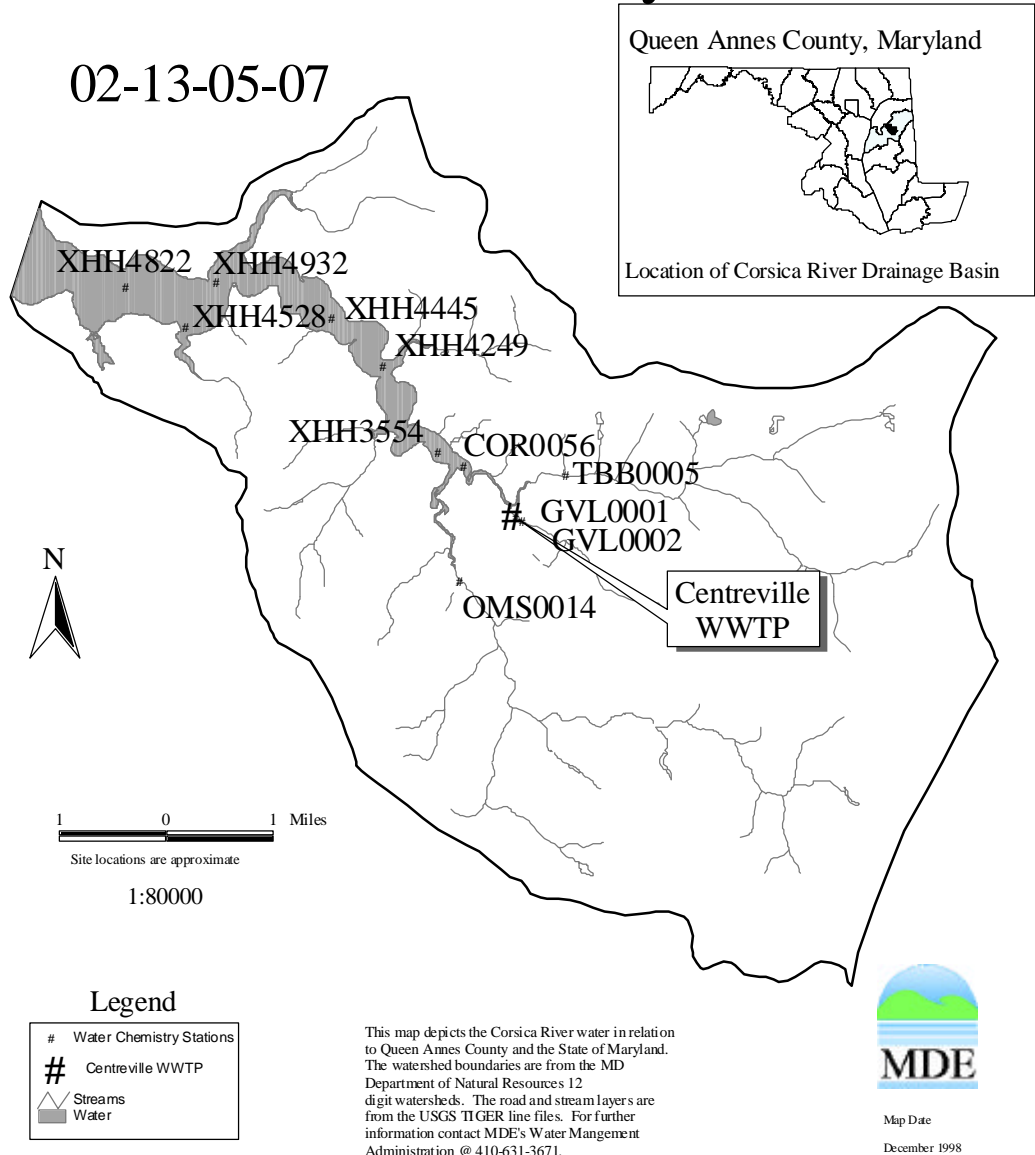

Figure A2: Location of Water Chemistry Sites on Corsica River Watershed

Table A2: Location of Water Quality Monitoring Stations in Corsica River

Water Quality Stations	Kilometers from the Mouth of Corsica River
GVL0002	8.871
COR0056	8.236
XHH3454	7.256
XHH4249	6.418
XHH4445	5.242
XHH4932	3.366
XHH4822	1.581

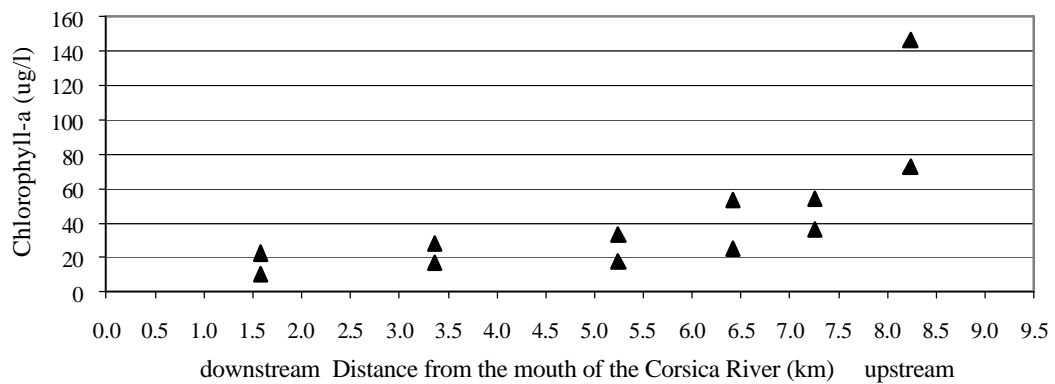

Figure A3: Longitudinal Profile of Chlorophyll-a Data of the Corsica River-- Summer 1997

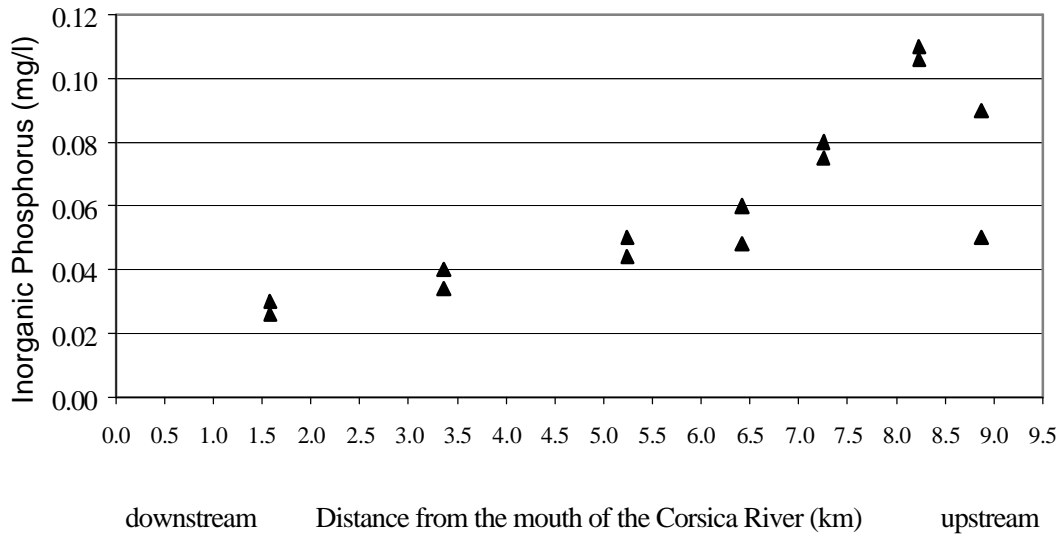

Figure A4: Longitudinal Profile of Inorganic Phosphorus Data of the Corsica River- Summer 1997

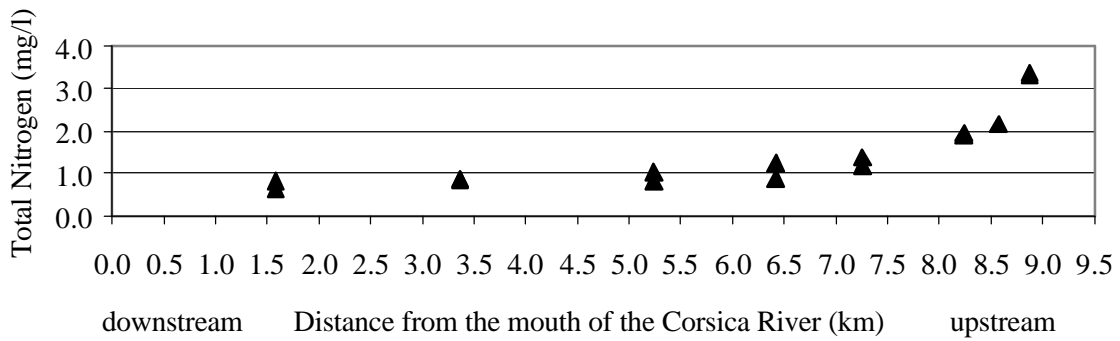

Figure A5: Longitudinal Profile of Total Nitrogen Data of the Corsica River- Summer 1997

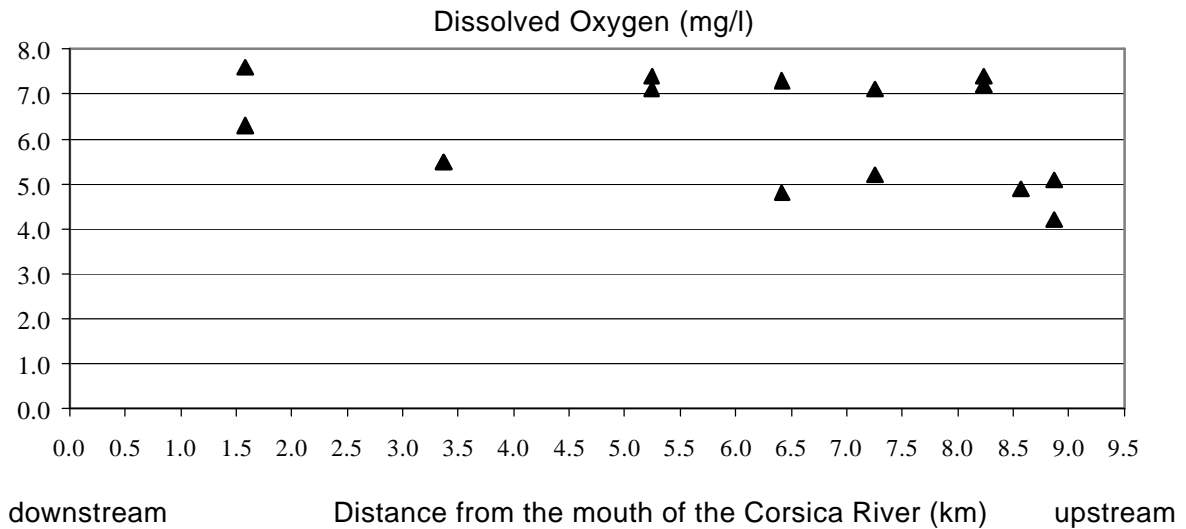

Figure A6: Longitudinal Profile of Dissolved Oxygen Data of the Corsica River- Summer 1997

MODELING FRAMEWORK

The computational framework chosen for the TMDL of Corsica River was WASP5. This program provides a generalized framework for modeling contaminant fate and transport in surface waters (Di Toro *et al.*, 1983) and is based on the finite-segment approach. It is a very versatile program, capable of studying time-variable or steady-state, one, two or three dimensional, linear or non-linear kinetic water quality problems. To date, WASP5 has been employed in many modeling applications that have included river, lake, estuarine and ocean environments, and the model has been used to investigate dissolved oxygen, eutrophication, and toxic substance problems. WASP5 has been used in a wide range of applications by regulatory agencies, consulting firms, and others.

WASP5 is supported and distributed by U.S. EPA's Center for Exposure Assessment Modeling (CEAM) in Athens, GA (Ambrose *et al.*, 1988). WASP5 is supplied with two kinetic sub-models, EUTRO5 and TOXI5, to simulate two of the major problems: conventional pollution (involving dissolved oxygen, biochemical oxygen demand, nutrients, and eutrophication) and toxic pollution (involving organic chemicals, metals, and sediment). EUTRO5 is the component of WASP5 that is applicable of modeling eutrophication, incorporating eight water quality constituents in the water column and sediment bed. Figure A7 shows the state variables and kinetic interactions in EUTRO5. TOXI5 is the component of WASP5 that is applicable to calibrate the dispersion by simulating the dye concentrations.

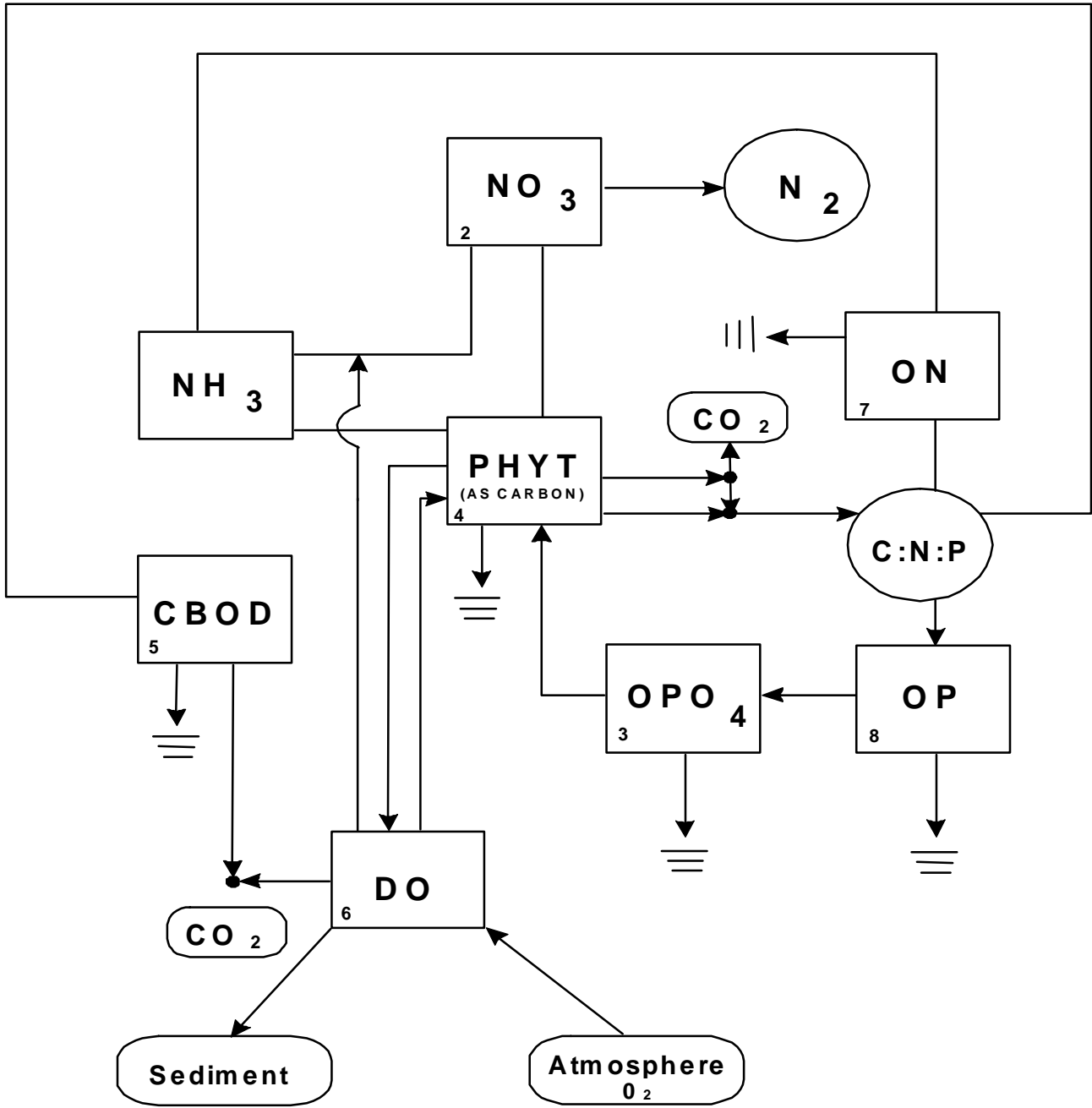

Figure A7: State Variables and Kinetic Interactions in EUTROWASP Model

The Corsica River Eutrophication Model (CREM) is calibrated and then validated into two stages: (1) for dispersion /exchange coefficients and (2) for kinetics

1. Dispersion/Exchange Coefficients

The hydrodynamic part of WASP5 is dispersion coefficients. The dispersion coefficients are calibrated using the data of September, 1997 dye study. The user manual for WASP5 suggests to use TOXI5 option for simulation of dye tracers using System 1-chemical 1 and bypass the other systems. In the model input data set, rate constants for chemical 1 are set to zero, so the model would simply perform the mass balance calculations without any chemical reactions. It also incorporates the transport and dilution of dye mainly through dispersion. Fresh water flows or advective flows which primarily include the plant and tributary flows are incorporated in the model's simulation. Simulation runs are made assuming steady-state conditions.

Kinetics

The nutrient enrichment, eutrophication, and D.O. depletion processes are incorporated in EUTRO5 through 8 systems which include nitrogen species (NH₃-N, NO₃-N, and ON-N), phosphorus species (inorganic phosphorus and organic phosphorus), phytoplankton carbon, dissolved oxygen, and CBOD. Several physical-chemical processes can affect the transport and interaction among nutrients, phytoplankton, carbonaceous materials, and dissolved oxygen. The rate constants for all eight systems are adjusted so that the model prediction for each system can best fit the actual observed data. These rate constants are validated using the second observed data.

INPUT REQUIREMENTS 1

Model Segmentation and Geometry

The spatial domain of the Corsica River Eutrophication Model for calibration and validation extends from the Gravel Run and Three Bridges Branch confluence to the confluence of Corsica River and Chester River for about 8.8 kilometers along the main stem of the Corsica River. Following a review of the bathymetry for the Corsica River, the model was divided into 16 segments. Figure A8 shows the model segmentation and the location of the WWTP. Figure A9 shows the modeling domain for Corsica River Eutrophication Model (CREM). Table A3 lists the characteristic lengths. Table A4 lists the volumes and interfacial areas. Calibrated exchange coefficients were used for model scenarios 1 through 5.

1 The WASP model requires all input data to be in metric units, and to be consistent with the model, all data in the Appendix will appear in metric units. Following are several conversion factors to aid in the comparison of numbers in the main document $\text{mgd} \times (0.0438) = \text{m}^3/\text{s}$; $\text{lb} / (2.2) = \text{kg}$; $\text{mg}/\text{l} \times \text{mgd} \times (8.34) / (2.2) = \text{kg}/\text{d}$

Corsica River Watershed

Model Segmentation for Eutrowasp

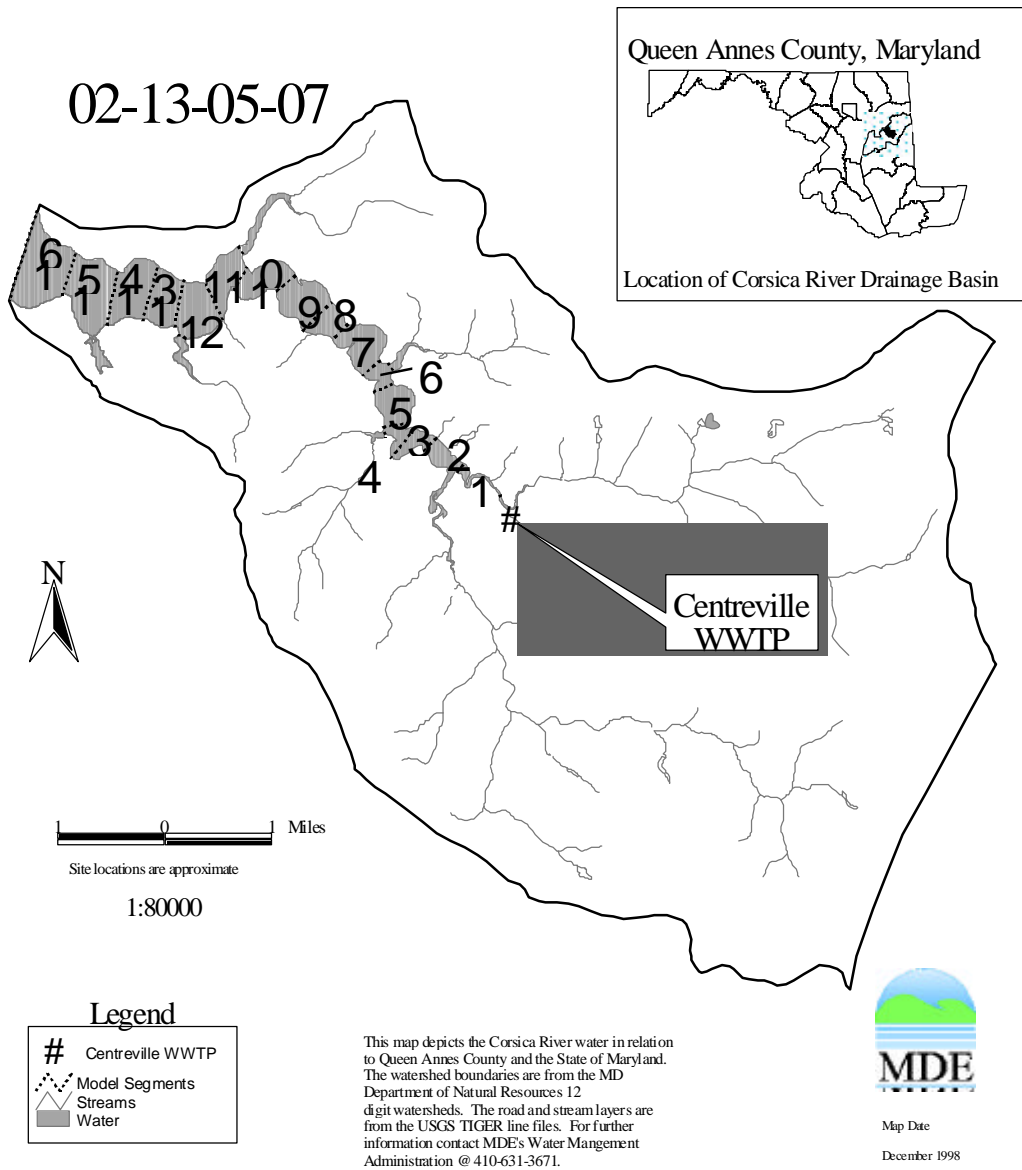

Figure A8: Model Segmentation including Location of WWTP

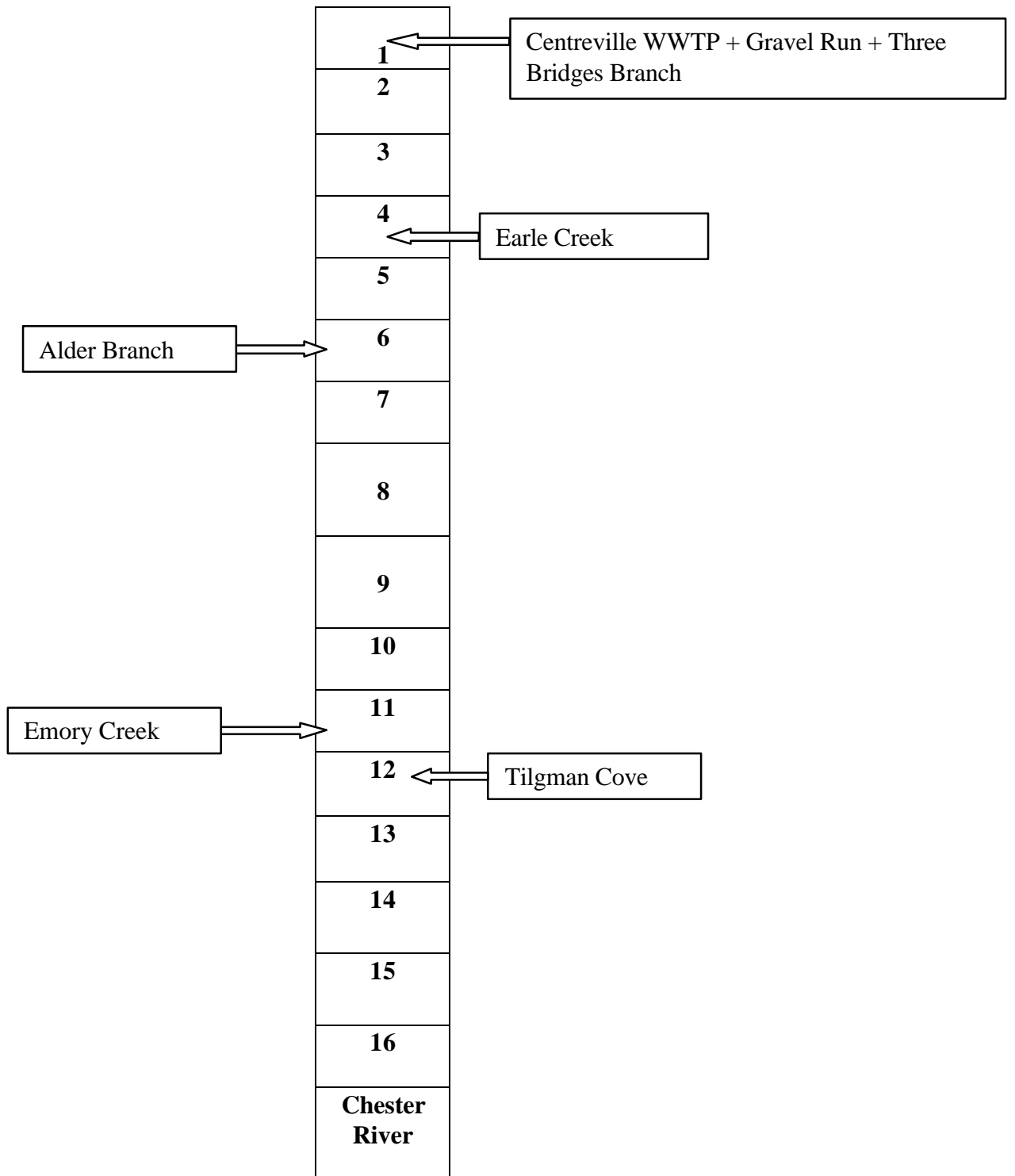

Figure A9: Modeling Domain for Corsica River Eutrophication Model (CREM)

Table A3: Characteristics Lengths

Segment Interface	Segment Number	Segment Length		Characteristic length	
		ft.	m	ft.	m
0-1				1975	602
	1	1975	602		
1-2				$(1975+2125)/2=2050$	625
0-2			267	$(1125+625)/2=875$	267
	2	2125			
2-3				$(2125+ 1400)/2=1763$	537
	3	1400	427		
0-4					305
3-4				$(1400+1500)/2= 1450$	442
	4	1500	457		
4-5				$(1500+1188)/2=1344$	410
	5	1188	362		
0-6					408
5-6				$(1188+1625)/2=1407$	429
	6	1625	495		
6-7				$(1625+2200)/2=1913$	583
	7	2200	671		
7-8				$(2200+1688)/2=1944$	593
	8	1688	515		
8-9				$(1688+1813)=1751$	534
	9	1813	553		
9-10				$(1813+2400)/2=2107$	642
	10	2400	732		
0-11					937
10-11				$(2400+2200)/2=2300$	701
	11	2200	671		
0-12					642
11-12				$(2200+2000)/2=2100$	640
	12	2000	610		
12-13				$(2000+1750)/2=1875$	572
	13	1750	534		
13-14				$(1750+2000)/2=1875$	572
	14	2000	610		
14-15				$(2000+2438)/2=2219$	676
	15	2438	743		
15-16				$(2438+1750)/2=2094$	638
	16	1750	533		
16-0				$(1750+1750)/2=1750$	533

Table A4: Volumes and Interfacial Areas

Interface	Segment #	Exchange Pair Area m ²	Average Depth m	Volume m ³
0-1		5.6		
	1		0.55	24526
1-2		84		
1-2		172		
	2		0.75	117054
2-4		214		
0-3		61		
	3		0.80	118912
3-4		446		
0-4		206		
3-4		446		
	4		0.75	125415
4-5		347		
	5		0.65	72462
5-6		248		
0-6		380		
5-6		248		
	6		1.01	131361
6-7		511		
	7		1.53	426311
7-8		697		
	8		1.91	440048
8-9		1208		
	9		2.67	694520
9-10		1213		
	10		3.20	772928
10-11		1162		
0-11		1462		
10-11		1162		
	11		2.74	610910
11-12		1207		
0-12		1022		
11-12		1207		
	12		2.59	1010566
12-13		1879		
	13		2.36	947134
13-14		1810		
	14		2.52	1142447
14-15		2787		
	15		2.44	1768073
15-16		1394		
	16		2.03	1101348
16-0		2515		

Freshwater Flows

The low and average flows for the 3 subwatersheds in the Corsica River basin were estimated using a nearby United States Geological Survey (USGS) flow gage. The USGS gage at Morgan Creek (01493500) was used because it is located nearby and assumed to have similar drainage area size. The ratio of flow to drainage area in Morgan Creek was multiplied by the area of each subwatershed to obtain the flow in the Corsica River watershed. The 7-day consecutive lowest flow expected to occur every 10 years, known as the 7Q10 flow, for Morgan Creek was 1.5 cfs. The yearly average flow was 10.6 cfs. The advective flows for calibration and validation were estimated using summer 1997 field surveys flow rates and contributing drainage areas for each tributary. For model scenarios 1 through 3, 7Q10 flow rate was used. For model scenario 4, 1997 summer flow rate was used. For model scenario 5, average flow rate was used.

Point and Nonpoint Source Loadings

There is only one point source nutrient load that discharge directly into the Corsica River. The point source loadings used in the calibration of the CREM were calculated using the July 1997 data for Centreville WWTP. The point source loadings used in the validation of CREM were calculated using the August 1997 data from Centreville WWTP. Table A5 shows the point source loads for the calibration model run. Table A6 shows the nonpoint source loadings for the calibration model run.

The nonpoint source loadings for the calibration and validation of the model were calculated using data from water quality stations within Corsica River Basin. Station TBB0005 was used as a boundary condition for Segment 1. Station XHH4822 was used as a boundary condition for Segment 16. No water quality stations were available for the tributaries draining to segments 4, 6, 8, 11, and 12. Water quality represented by station TBB0005 was used as a boundary for these segments. Nonpoint source loads for low flow were estimated using 7Q10 flow rate and 1997 field survey pollutant concentrations. Nonpoint source loads for average flows were based upon year 2000 tributary strategies loads. The nonpoint source loads reflect atmospheric deposition, loads coming from septic tanks, loads coming from urban development, agriculture, and forest land. Table A7 shows the point source loads for scenario 1 and 2. For the point source loads for scenarios 3,4, and 5 refer to the technical memorandum entitled *Significant Nutrient Point Sources in the Corsica River watershed*. Table A8 shows the nonpoint sources loadings for scenario 1 and 2. The nonpoint source loads for other scenarios are based on the allocation described in the technical memorandum entitled *Significant Nutrient nonpoint Sources in the Corsica River watershed*

For both point and nonpoint sources, the concentrations of the nutrients nitrogen and phosphorus are modeled in their speciated forms. The WASP5 model simulates nitrogen as ammonia (NH₃), nitrate + nitrite (NO₃) and organic nitrogen (ON), and phosphorus as ortho-phosphate (PO₄) and organic phosphorus (OP). Ammonia, nitrate, and ortho-phosphate represent the dissolved forms of nitrogen and phosphorus. The dissolved forms of nutrients are more readily available for chemical processes such as algae growth, that can affect chlorophyll-a levels and dissolved oxygen concentrations. The ratios of total nutrients to dissolved nutrients used in the model scenarios represent values that have been used based upon past modeling experience.

Table A5: Point Source Loadings for the Calibration Run

Point Source	Flow m ³ /s	NH4 kg/d	NO23 kg/d	PO4 kg/d	Chl-a kg/d	CBOD kg/d	DO kg/d	ON kg/d	OP kg/d
Centreville WWTP	.0127	3.94	1.65	2.34	0	15.27	5.41	5.64	0.63

Table A6: Nonpoint Source Loadings for the Calibration Run

Segment Number	Flow m ³ /s	NH4 kg/d	NO23 kg/d	PO4 kg/d	Chl-a kg/d	CBOD kg/d	DO kg/d	ON kg/d	OP kg/d
Segment 1	.0565	0.23	22.15	0.58	0	7.34	31.98	3.37	0.50
Segment 2	.0647	0.21	30.3	0.44	0.15	8.42	36.7	3.87	0.57
Segment 4	.0124	0.05	4.88	0.13	0	1.61	7.04	0.74	0.11
Segment 6	.0088	0.04	3.43	0.09	0	1.14	4.96	0.52	0.08
Segment 11	.0122	0.05	4.77	0.12	0	1.58	6.89	0.73	0.11
Segment 12	.0043	0.017	1.67	0.04	0	0.55	2.40	0.25	0.04

Table A7: Point Source Loadings for the Model Scenarios

Scenarios		1	2*
		(Segment 1)	(Segment 2)
Centreville WWTP			
NH3	kg/d	12.08	12.08
NO23	kg/d	3.61	3.61
PO4	kg/d	3.38	3.38
Chl-a	kg/d	0	0
CBOD	kg/d	23.80	23.80
DO	kg/d	6.54	6.54
ON	kg/d	6.44	6.44
OP	kg/d	0.75	0.75
Flow	m ³ /s	0.01642	0.01642

* proposed downstream outfall location

Table A8: Nonpoint Source Loadings for the Model Scenarios

Scenarios		1	2
Segment 1			
NH3	kg/d	0.065	0.065
NO23	kg/d	2.21	2.21
PO4	kg/d	0.061	0.061
Chl-a	kg/d	0.0	0.0
CBOD	kg/d	0.99	0.99
DO	kg/d	3.85	3.85
ON	kg/d	0.44	0.44
OP	kg/d	0.048	0.048
Flow	m ³ /s	0.0055	0.0055
Segment 2			
NH3	kg/d	0.015	0.015
NO23	kg/d	2.173	2.173
PO4	kg/d	0.032	0.032
Chl-a	kg/d	0	0
CBOD	kg/d	0.605	0.605
DO	kg/d	3.136	3.136
ON	kg/d	0.227	0.227
OP	kg/d	0.016	0.016
Flow	m ³ /s	0.0045	0.0045

Table A8: Nonpoint Source Loadings for the Model Scenarios, continued

Scenarios		1	2
Segment 4			
NH3	kg/d	0.00017	0.00017
NO23	kg/d	0.333	0.333
PO4	kg/d	0.009	0.009
Chl-a	kg/d	0.0	0.0
CBOD	kg/d	0.116	0.116
DO	kg/d	0.48	0.48
ON	kg/d	0.05	0.05
OP	kg/d	0.008	0.008
Flow	m ³ /s	0.0008	0.00085
Segment 6			
NH3	kg/d	0.004	0.004
NO23	kg/d	0.343	0.343
PO4	kg/d	0.009	0.009
Chl-a	kg/d	0.0	0.0
CBOD	kg/d	0.116	0.116
DO	kg/d	0.50	0.50
ON	kg/d	0.052	0.052
OP	kg/d	0.007	0.007
Flow	m ³ /s	0.00088	0.00088
Segment 11			
NH3	kg/d	0.004	0.004
NO23	kg/d	0.343	0.343
PO4	kg/d	0.009	0.009
Chl-a	kg/d	0.0	0.0
CBOD	kg/d	0.116	0.116
DO	kg/d	0.50	0.50
ON	kg/d	0.052	0.052
OP	kg/d	0.007	0.007
Flow	m ³ /s	0.00085	0.00085
Segment 12			
NH3	kg/d	0.012	0.012
NO23	kg/d	0.11	0.11
PO4	kg/d	0.003	0.003
Chl-a	kg/d	0.0	0.0
CBOD	kg/d	0.037	0.037
DO	kg/d	0.16	0.16
ON	kg/d	0.017	0.017
OP	kg/d	0.0025	0.0025
Flow	m ³ /s	0.000028	0.000028

Environmental Conditions

Significant environmental parameters used for the calibration of the CREM are given in Table A9

Light extinction coefficients, K_e in the water column were derived from Secchi depth measurements using the following equation:

$$K_e = \frac{1.90}{D_s}$$

Where: K_e = light extinction coefficient (m^{-1})
 D_s = Secchi depth (m)

The SOD in the upper reaches of the Corsica River was higher due to the high concentrations of chlorophyll-a which were settling out and the high inputs of nutrients and BOD from the Centreville WWTP. A value of 5.5 mg O_2/m^2 day was used for calibration and validation runs of the model. This value is considered reasonable based on the condition of the stream and the literature (Thomann, 1987). Lower values were considered for the model run scenarios for the advanced level of treatment for the WWTP.

Kinetic Coefficients

The water column kinetic coefficients are universal constants used in the EUTRO5 model. They are formulated to characterize the kinetic interactions among the water quality constituents. The initial values were taken from past modeling studies of the Potomac River (Clark and Roesh, 1978), (Thomann and Fitzpatrick, 1982) and of Mattawoman Creek (Panday and Haire, 1986, Domotor et al., 1987), and the Patuxent River (Lung, 1993). The kinetic coefficients are listed in Table A10.

Initial Conditions

The initial conditions used in the model were as close to the observed values as possible. However, since the model was run for a long period of time (35 days) it was found that initial conditions did not impact the final results.

Table A9: Environmental Parameters for the Calibration of the Model

Calibration Environmental Parameters

Segment	Ke	T	Salinity
	m ⁻¹	°C	g/l
1	6.33	27.6	3.0
2	4.75	27.5	3.7
3	4.75	27.5	3.8
4	4.75	27.5	5.6
5	4.75	27.6	5.6
6	4.75	27.5	6.0
7	4.75	27.5	6.3
8	3.20	27.5	6.4
9	3.20	27.6	6.4
10	3.20	27.5	6.6
11	3.20	27.5	6.9
12	2.71	27.5	7.1
13	2.71	27.6	7.2
14	2.71	27.5	7.4
15	2.71	27.5	7.6
16	2.71	27.5	7.6

Table A10: EUTRO5 Kinetic Coefficients

Constant	Code	Value
Nitrification rate temperature coefficient	K12C K12T	0.15 day ⁻¹ at 20 ⁰ C 1.08
Denitrification rate temperature coefficient	K20C K20T	0.019 day ⁻¹ at 20 ⁰ C 1.08
Saturated growth rate of phytoplankton temperature coefficient	K1C K1T	2.0 day ⁻¹ at 20 ⁰ C 1.08
Endogenous respiration rate temperature coefficient	KIRC KIRT	0.125 day ⁻¹ at 20 ⁰ C 1.045
Nonpredatory phytoplankton death rate	KID	0.02 day ⁻¹
Phytoplankton Stoichiometry Oxygen to carbon ratio Carbon to chlorophyll ratio Nitrogen to carbon ratio Phosphorus to carbon ratio	ORCB CCHL NCRB PCRB	2.67 mg O ₂ / mg C 30 0.25mg N/ mg C 0.025 mg PO ₄ - P/ mg C
Half-saturation constants for phytoplankton growth Nitrogen Phosphorus	KMNG1 KMPG1	0.019 mg N / L 0.001 mg PO ₄ -P/ L
Fraction of dead phytoplankton recycled to organic Nitrogen Phosphorus	FON FOP	0.5 0.5
Light formulation switch	LGHTS	1= Smith
Saturation light intensity for phytoplankton	ISI	300 Ly/ day
BOD deoxygenation rate temperature coefficient	KDC KDT	0.20 day ⁻¹ at 20 ⁰ C 1.045
Mineralization rate of organic nitrogen temperature coefficient	K71C K71T	0.078 day ⁻¹ 1.08
Mineralization rate of organic phosphorus temperature coefficient	K83C K83T	0.20 day ⁻¹ 1.08

CALIBRATION, VALIDATION, AND SENSITIVITY ANALYSIS

Calibration

The EUTRO5 model was calibrated with July 1997 water quality data. Table A5 shows the point source loads for the calibration. Table A6 shows the nonpoint source loads for the calibration. Nonpoint source loads for some tributaries were input as boundary concentration and flows associated with those boundary concentrations. Boundary concentrations for the tributary flows not recorded during field survey were estimated based upon best engineering judgement. The calibration is also represented as calibration run in the main document. Table A6 shows the tributary flows. Figures A10 through A17 show the results of the calibration run. As can be seen in Figure A10 through A17, the model did a good job of capturing the trend in all the parameters. The model did an excellent job of capturing the peak chlorophyll-a concentrations and also the general trend (Figure A10).

Validation

The EUTRO5 model was validated with August 1997 water quality data. Nonpoint source loads for some tributaries were input as boundary concentration and flows associated with those boundary concentrations. Boundary concentrations for the tributary flows not recorded during field survey were estimated based upon best engineering judgement. The validation is also represented as validation run in the main document. Figures A18 through A25 show the results of the validation run. As can be seen in Figure A18 through A25 the model did a good job of capturing the trend in all the parameters. The model did an excellent job of capturing the peak chlorophyll-a concentrations and also the general trend (Figure A18).

Summary of the Output Results for the Calibration of the Model

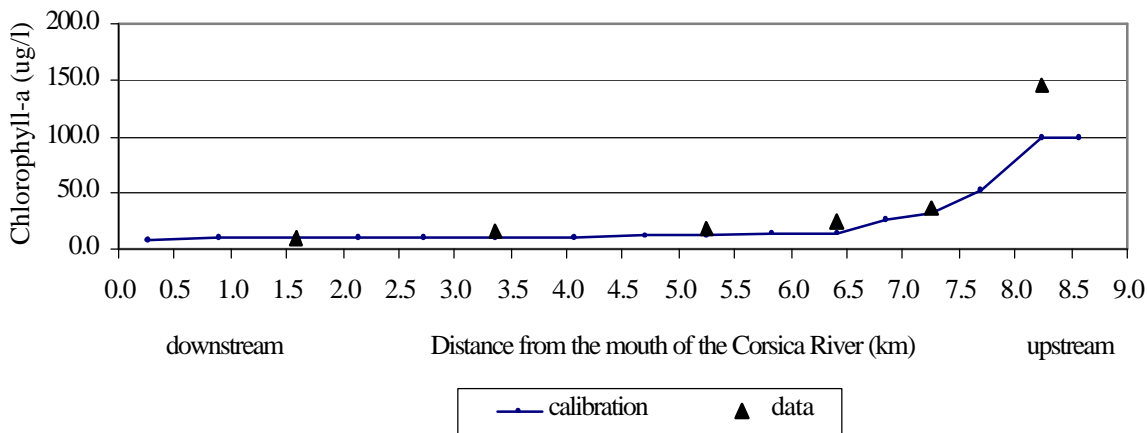

Figure A10: Chlorophyll-a vs River Kilometers for the Calibration of the Model (CREM)

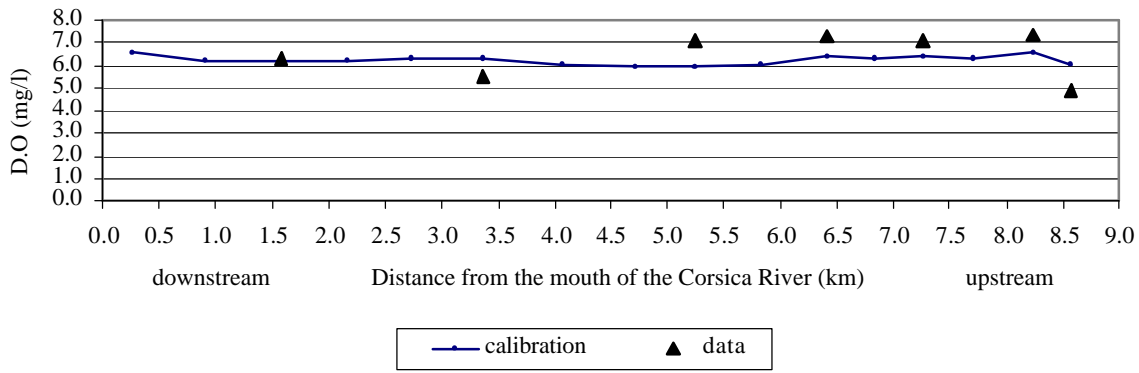

Figure A11: Dissolved Oxygen vs River Kilometers for the Calibration of the Model (CREM)

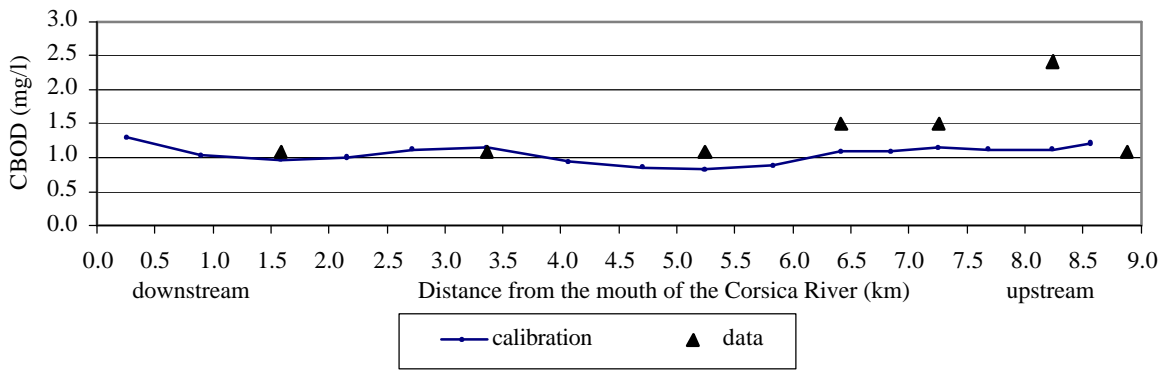

Figure A12: CBOD vs River Kilometers for the Calibration of the Model

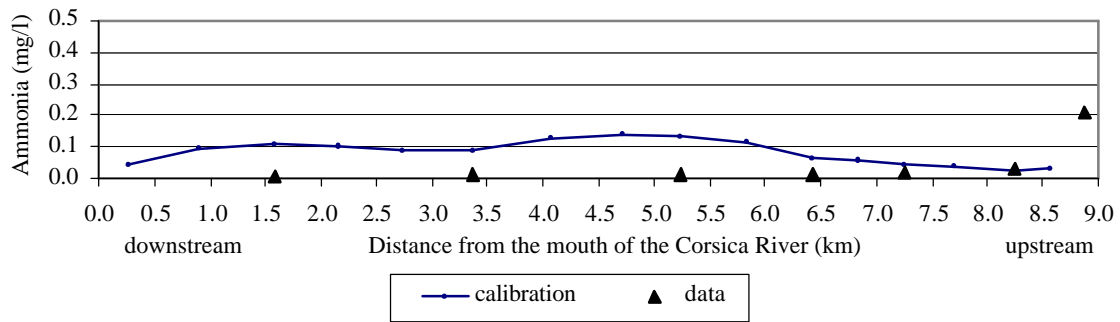

Figure A13: Ammonia vs River Kilometers for the Calibration of the Model

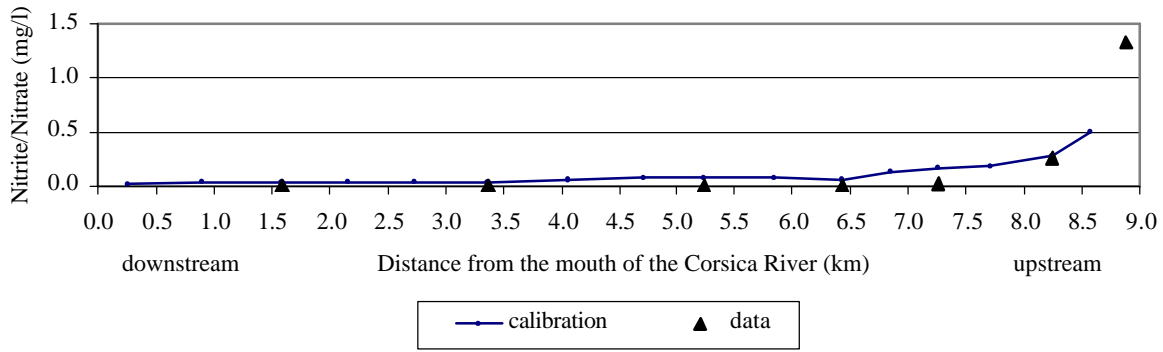

Figure A14: Nitrate (plus Nitrite) vs River Kilometers for the Calibration of the Model

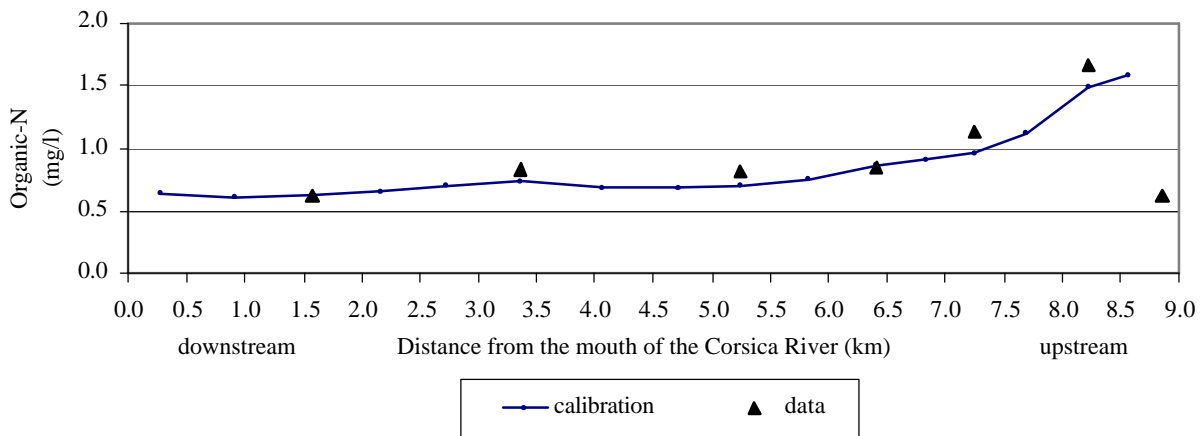

Figure A15: Organic Nitrogen vs River Kilometers for the Calibration of the Model

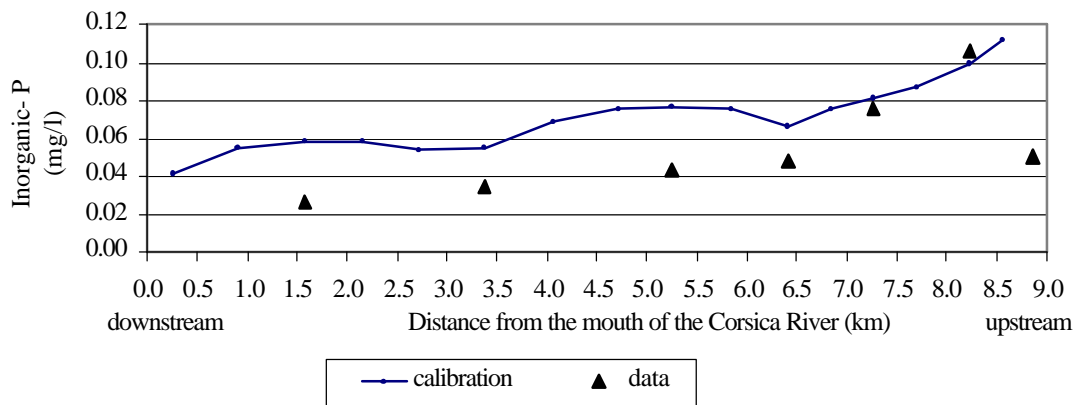

Figure A16: Inorganic Phosphorus vs River Kilometers for the Calibration of the Model

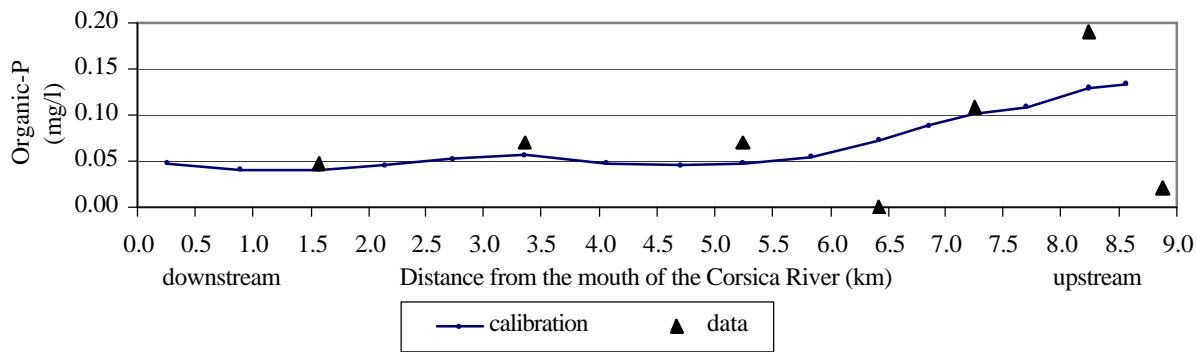

Figure A17: Organic Phosphorus vs River Kilometers for the Calibration of the Model

Summary of the Output Results for the Validation of the Model

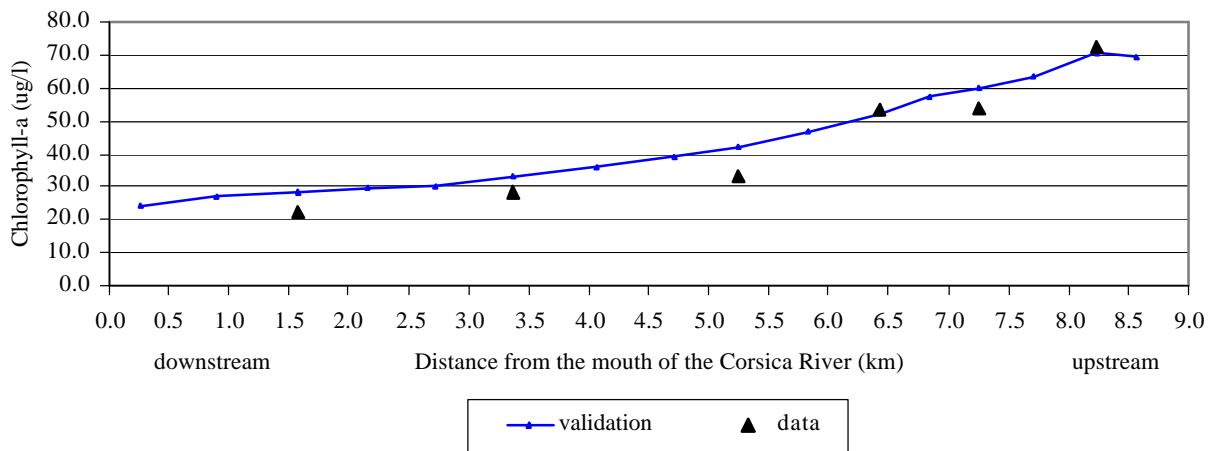

Figure A18: Chlorophyll-a vs River Kilometers for the Validation of the Model

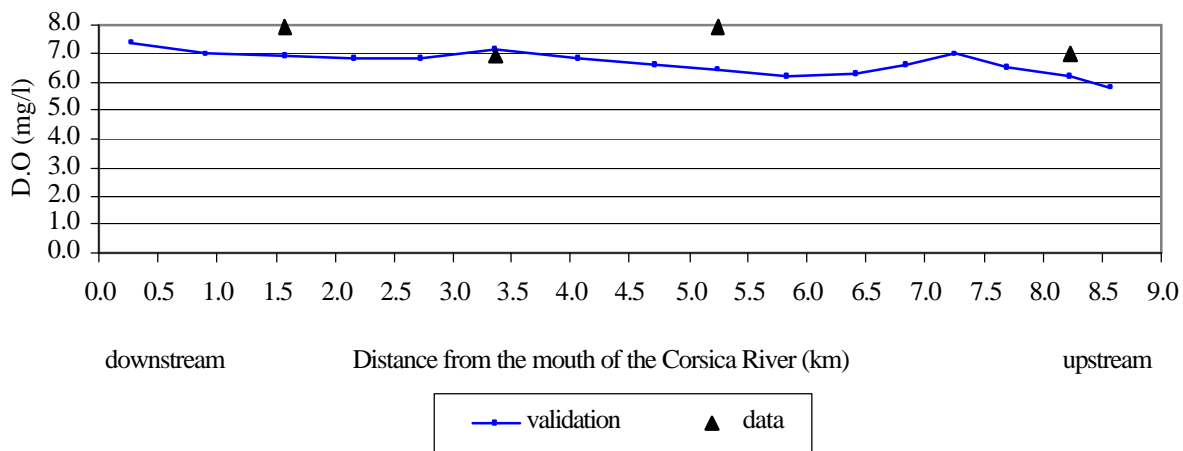

Figure A19: Dissolved Oxygen vs River Kilometers for the Validation of the Model

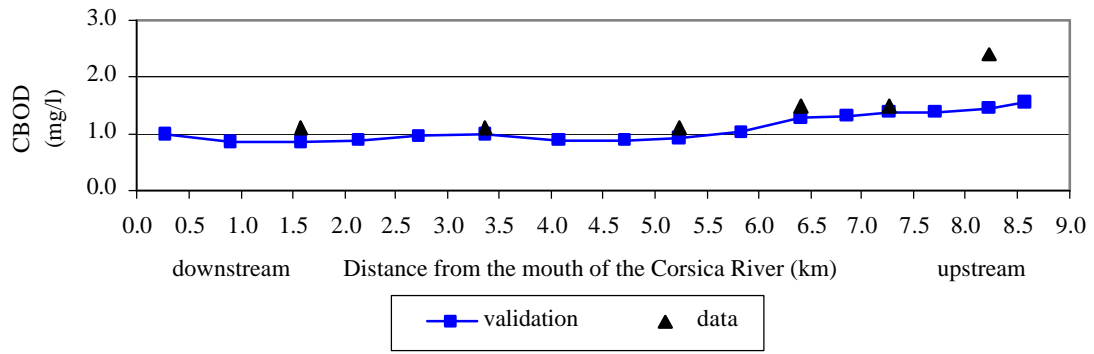

Figure A20: CBOD vs River Kilometers for the Validation of the Model

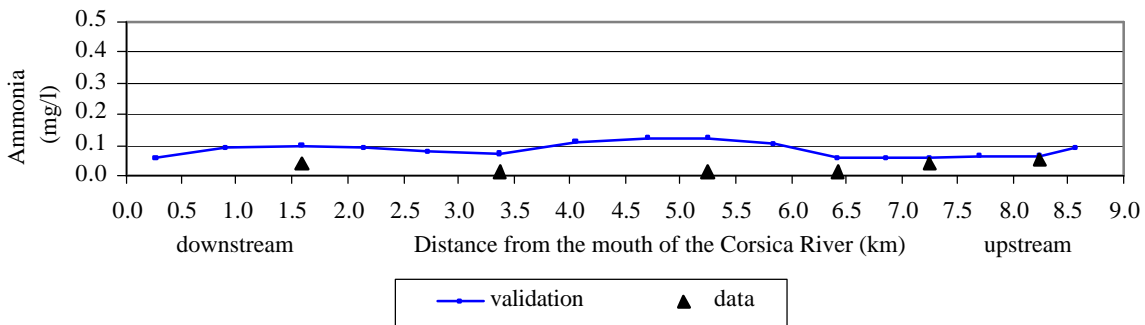

Figure A21: Ammonia vs River Kilometers for the Validation of the Model

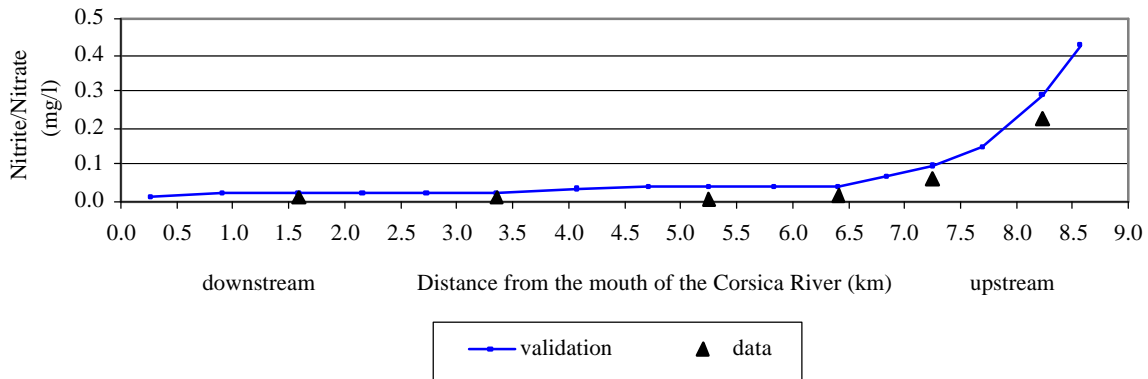

Figure A22: Nitrate (plus Nitrite) vs River Kilometers for the Validation of the Model

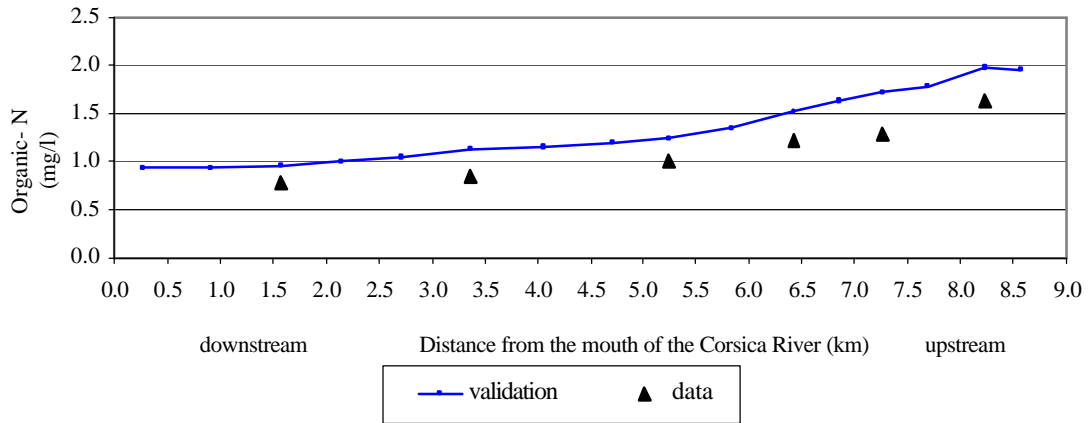

Figure A23: Organic Nitrogen vs River Kilometers for the Validation of the Model

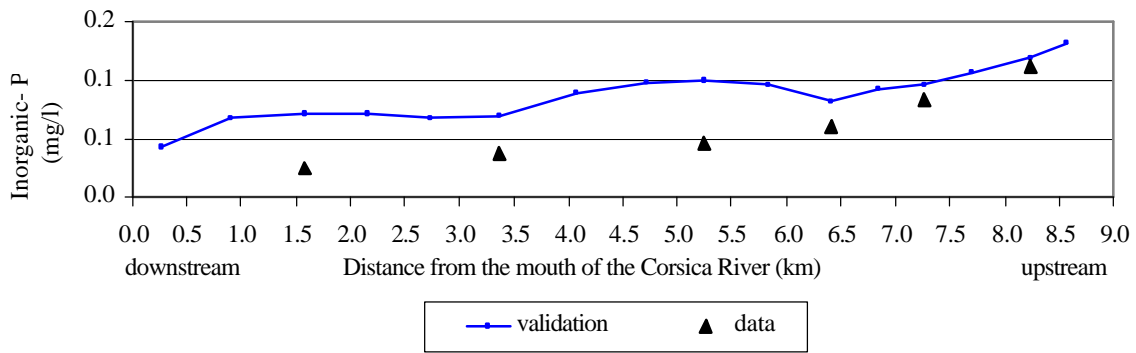

Figure A24: Inorganic Phosphorus vs River Kilometers for the Validation of the Model

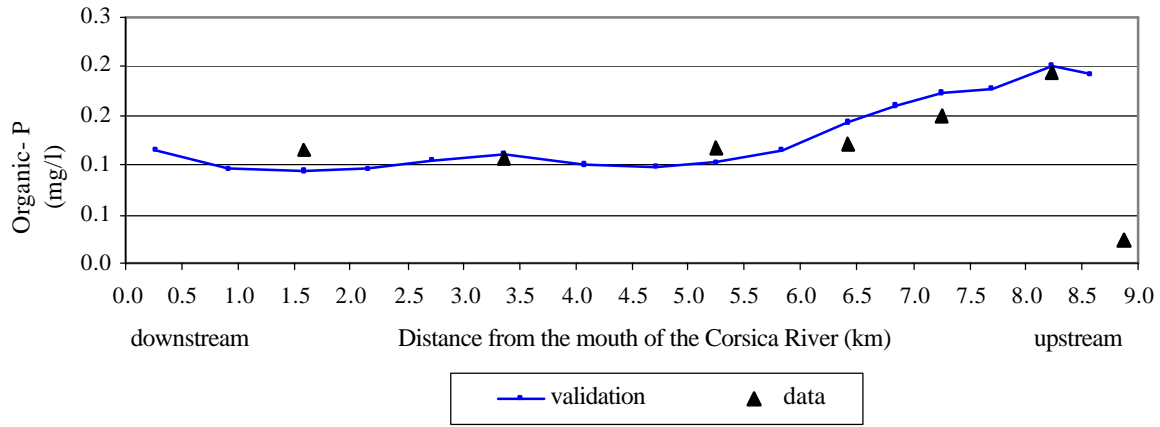

Figure A25: Organic Phosphorus vs River Kilometers for the Validation of the Model

SYSTEM RESPONSE

The calibrated and validated CREM was applied to several different point and nonpoint source loading conditions under various stream flows to project the impacts of nutrients on the eutrophication of the River. By modeling various stream flows, in particular the 7Q10 conditions, the model runs simulate impact of seasonal conditions, which is a necessary element of the TMDL development process.

A sensitivity analysis was performed using estimated high flows (0.918 m³/s, 32.46 cfs) in Corsica River system. The results can be seen in Figure A34 through A41. As can be seen the chlorophyll-a concentrations were reduced compared to the calibration results of the model.

Scenarios Description

The first scenario represents the base case conditions of the stream at low flow, (0.0127 m³/s, 0.45 cfs) for current level of treatment at the current discharge location, the nonpoint source flow in the basin, and the warm water temperature (above 25 °C). The nonpoint source (NPS) loads were computed using 1997 flow field data. The nonpoint source loads reflect atmospheric deposition, loads from septic tanks, and other nonpoint sources loads coming off the land. The point source loads for Centreville WWTP represent the design flow multiplied by the corresponding concentration of current level of treatment. All the environmental parameters and kinetic coefficients used for the calibration of the model remained the same for scenario 1. This represents the 7Q10 Base Conditions 1 at the current discharge location.

The second scenario represents the stream at low flow, (0.0127 m³/s, 0.45 cfs) for current level of treatment at the proposed downstream discharge location, the nonpoint source flow in the basin, and warm water temperature (above 25 °C). The nonpoint source (NPS) loads were computed using 1997 flow data. The nonpoint source loads reflect atmospheric deposition, loads from septic tanks, and other nonpoint sources loads coming off the land. The point source loads for Centreville WWTP represent the design flow multiplied by the corresponding concentration of secondary level treatment. However, these loads were assumed for the proposed outfall location, downstream of Watson Road Bridge. All the environmental parameters and kinetic coefficients used for the calibration of the model remained the same for scenario 2. This represents the 7Q10 Base Conditions 2 at the proposed discharge location.

The third scenario represents the stream at low flow, (0.0127 m³/s, 0.45 cfs) for Biological Nitrogen Removal (BNR) treatment at the proposed downstream discharge location, the nonpoint source flow in the basin, and warm water temperature (above 25 °C). The nonpoint source (NPS) loads were computed using 1997 base flow field data. The nonpoint source loads reflect atmospheric deposition, loads from septic tanks, and other nonpoint sources loads coming off the land. The point source loads for Centreville WWTP represent the design flow multiplied by the corresponding projected concentrations of Biological Nitrogen Removal (BNR) treatment. These loads were assumed for the proposed outfall location, downstream of Watson Road Bridge. It was also assumed that the SOD rate would decrease in the upper reach to the same rate as in the lower reaches. All the environmental parameters and kinetic coefficients used for the calibration of the model remained the same for scenario 3. This scenario establishes **the final conditions** for TMDL projections during low flow conditions. This represents the 7Q10 Final Conditions.

The fourth scenario represents the sensitivity analysis using 1997 summer low flow, (0.1839 m³/s, 6.50 cfs), the nonpoint source flow in the basin, and warm water temperature (above 25 °C). The nonpoint source (NPS) loads were computed using 1997 base flow field data. The nonpoint source loads reflect atmospheric deposition, loads from septic tanks, and other nonpoint sources loads coming off the land. The point source loads for Centreville WWTP represent the design flow multiplied by the corresponding projected concentrations of Biological Nitrogen Removal (BNR) treatment. These loads were assumed for the proposed outfall location, downstream of Watson Road Bridge. It was also assumed that the SOD rate would decrease in the upper reach to the same rate as in the lower reaches. All the environmental parameters and kinetic coefficients used for the calibration of the model remained the same for scenario 4. This represents the 1997 Low Flow Base Conditions at the proposed discharge location, downstream of Watson Road Bridge.

The fifth scenario represents the sensitivity analysis using average stream flow, (0.902 m³/s, 31.50 cfs) for BNR at the treatment plant discharging at the proposed downstream location, the nonpoint source flow in the basin, and warm water temperature (above 25 °C). The nonpoint source (NPS) loads reflect estimated year 2000 loads for both nitrogen and phosphorus. The year 2000 nonpoint source loads were calculated using the same methodology described in the beginning of the document. The year 2000 loading rates were based on the results of the Chesapeake Bay Model (U.S. EPA, 1991), and accounted for loads from both atmospheric deposition and septic tanks, and other nonpoint sources loads coming off the land. The point source loads for Centreville WWTP represent the design flow multiplied by the corresponding projected concentrations of Biological Nitrogen Removal (BNR) treatment. These loads were assumed for the proposed outfall location, downstream of Watson Road Bridge. It was also assumed that the SOD rate would decrease in the upper reaches to the same value as assumed for the lower reaches. All the environmental parameters and kinetic coefficients used for the calibration of the model remained the same for scenario 5. This scenario establishes the final condition for TMDL projection during average flow condition. This scenario is represented as Average Flow Final Conditions.

The results of the scenarios 3 and 5, the final conditions for TMDLs, can be seen in Figures A34-A41. The results of the third scenario indicate that, under 7Q10 condition, the water quality target for dissolved oxygen and chlorophyll-a is satisfied at all locations along the main stem of the Corsica River. The fifth scenario shows that water quality standards for both chlorophyll-a and dissolved oxygen are achieved along the entire length of Corsica River during average flow conditions.

7Q10 Base Case Conditions Scenarios Output Results (refer Figures A26 thru A34)

1. Scenario 1 (7Q10 Base Case Conditions 1): Assumes 7Q10 stream flow conditions. Assumes the summer 1997 nonpoint source concentrations and current level of treatment for Centreville WWTP at the current location. Nonpoint source loads were simulated for 7Q10 flow plus a 3% margin of safety (MOS) The output results of this scenario are represented as 7Q10 Base Case in Figures A26 through A33.
2. Scenario 2 (7Q10 Base Case Conditions 2): Assumes 7Q10 stream flow conditions. Assumes the summer 1997 nonpoint source concentrations and current level of treatment for Centreville WWTP at the downstream location. . Nonpoint source loads were simulated for 7Q10 flow plus a 3% margin of safety (MOS) The output results of this scenario are represented as Scenario 2 in Figures A26 through A33.
3. Scenario 4 (1997 Low Flow Base Conditions): Assumes 1997 summer low flows. Assumes the summer 1997 nonpoint source concentrations and BNR and CPR level of treatment for Centreville WWTP at the proposed downstream location. Nonpoint source loads were simulated for 1997 low flows plus a 3% margin of safety (MOS) The output results of this scenario are represented as Scenario 4 in Figures A26 through A33.

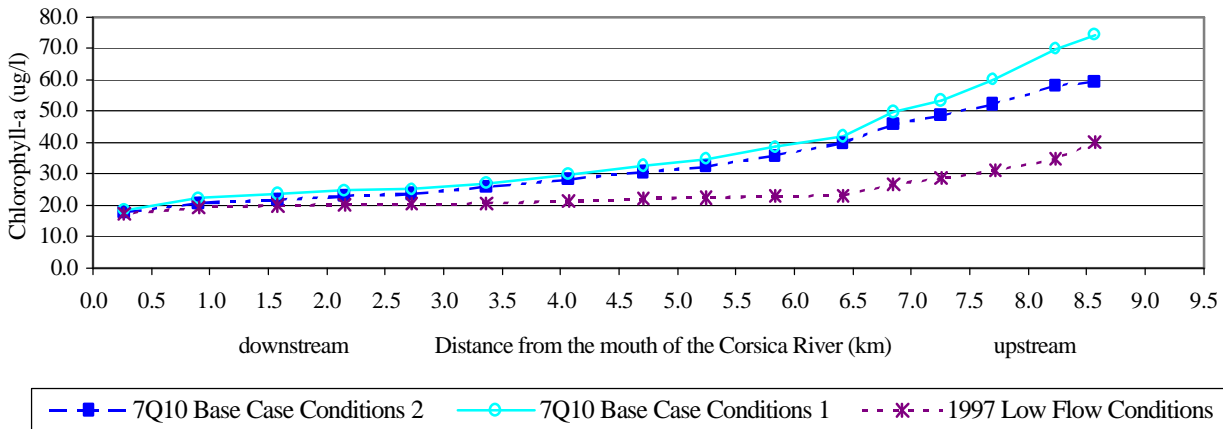

Figure A26: Chlorophyll-a vs River Kilometers for the Base Case Scenarios

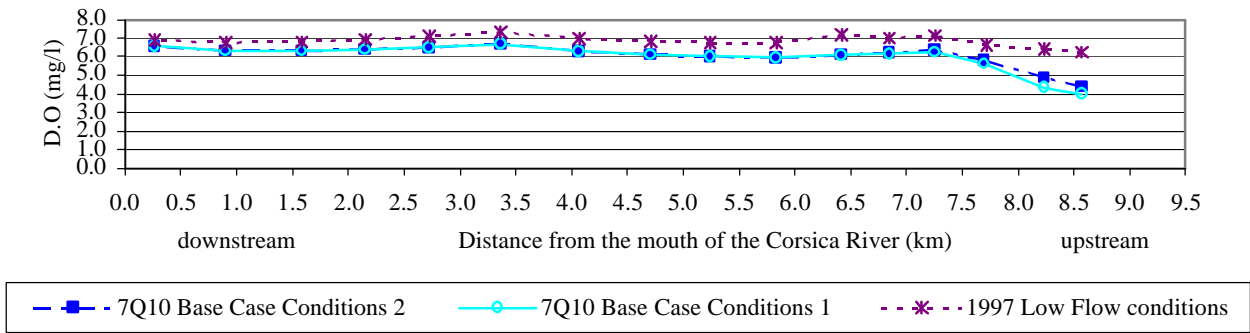

Figure A27: Dissolved Oxygen vs River Kilometers for the Base Case Scenarios

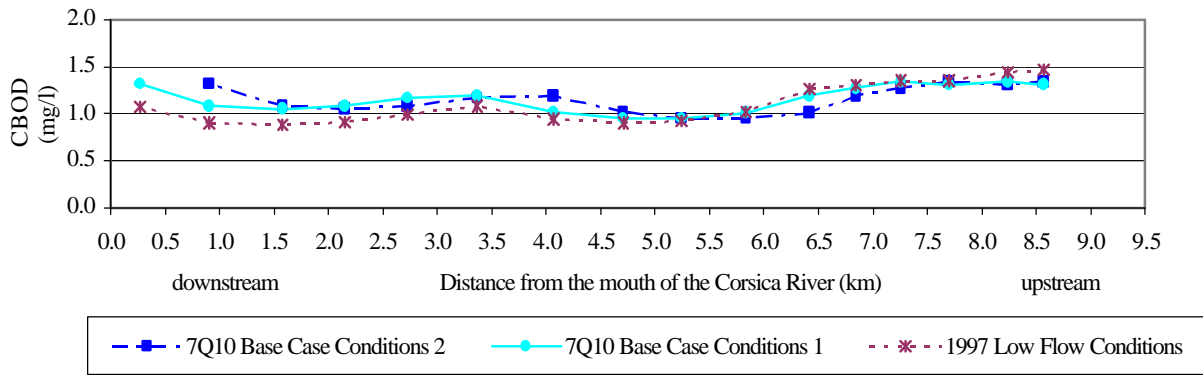

Figure A28: CBOD vs River Kilometers for the Base Case Scenarios

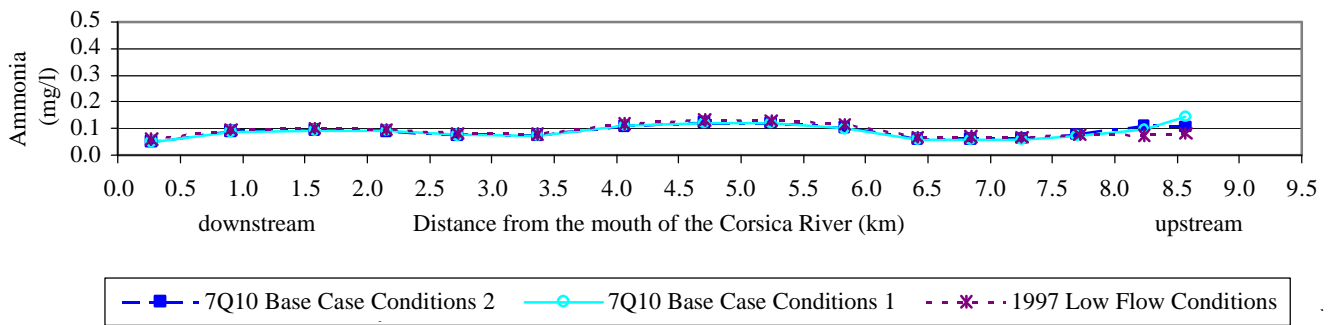

Figure A29: Ammonia vs River Kilometers for the Base Case Scenarios

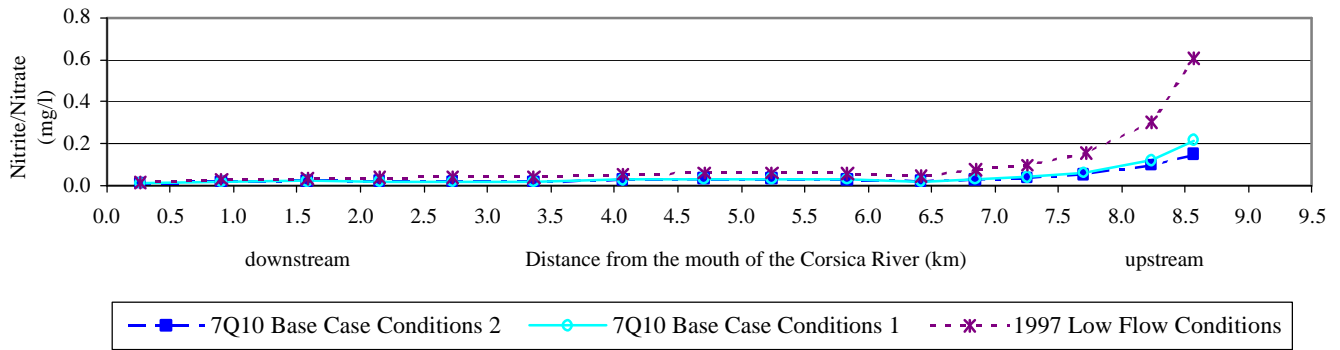

Figure A30: Nitrite/Nitrate vs River Kilometers for the Base Case Scenarios

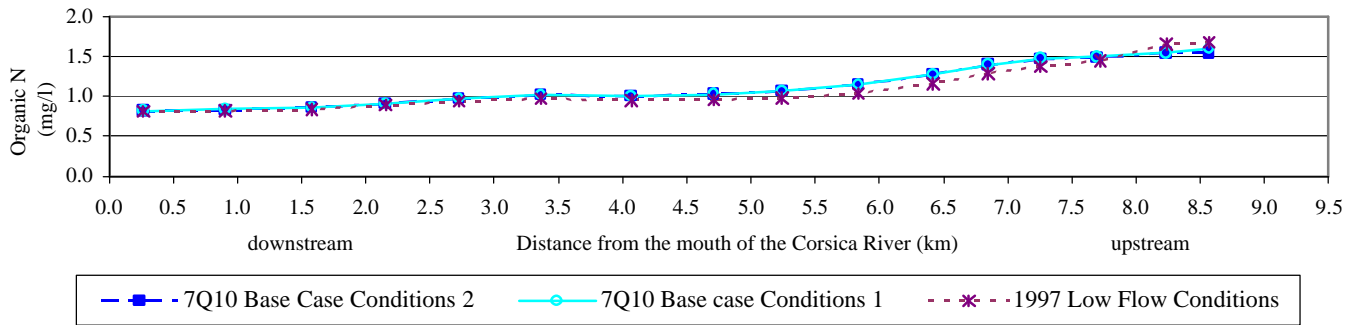

Figure A31: Organic - N vs River Kilometers for the Base Case Scenarios

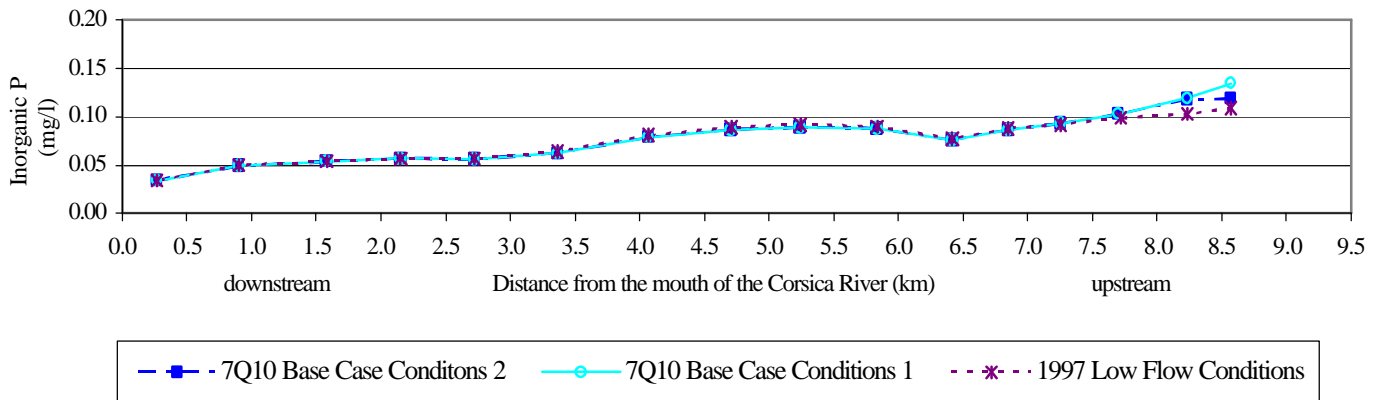

Figure A32: Inorganic Phosphorus vs River Kilometers for the Base Case Scenarios

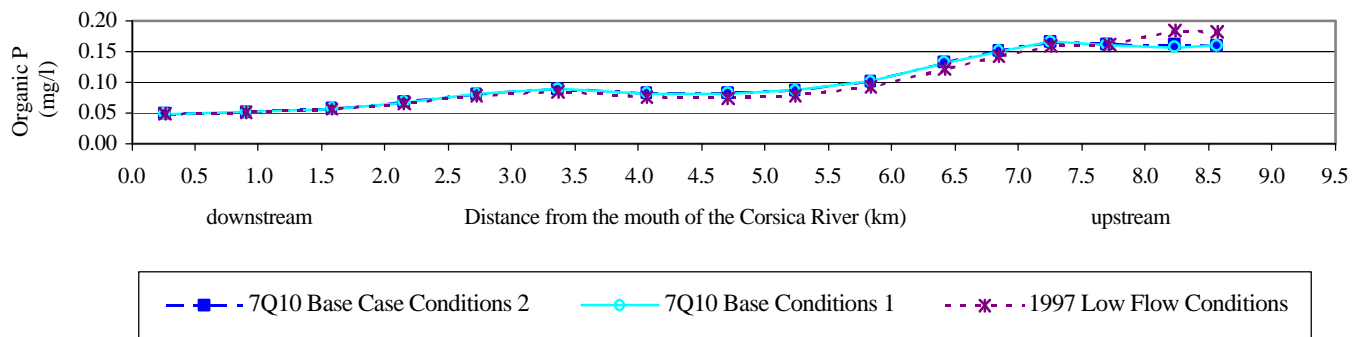

Figure A33: Organic Phosphorus vs River Kilometers for the Base Case Scenarios

Final Conditions Scenarios Output Results (refer Figures A34 thru A41)

4. Scenario 3 (7Q10 Final Conditions): Assumes 7Q10 stream flow. Assumes the summer 1997 nonpoint source concentrations and BNR and CPR level of treatment for Centreville WWTP at the downstream location. Nonpoint source loads were simulated for 7Q10 flow plus a 5% margin of safety (MOS). The output results of this scenario are represented as 7Q10 Final Conditions in Figures A34 through A41.
5. Scenario 5 (Average Flow Final Conditions): Assumes average stream flow conditions. Nonpoint source loads are based on the year 2000 loading rates plus a 3% margin of safety (MOS). Assume BNR and CPR level of treatment for Centreville WWTP at the downstream location. The output results of this scenario are represented as Avg. Flow Final Conditions in figures A34 through A41.

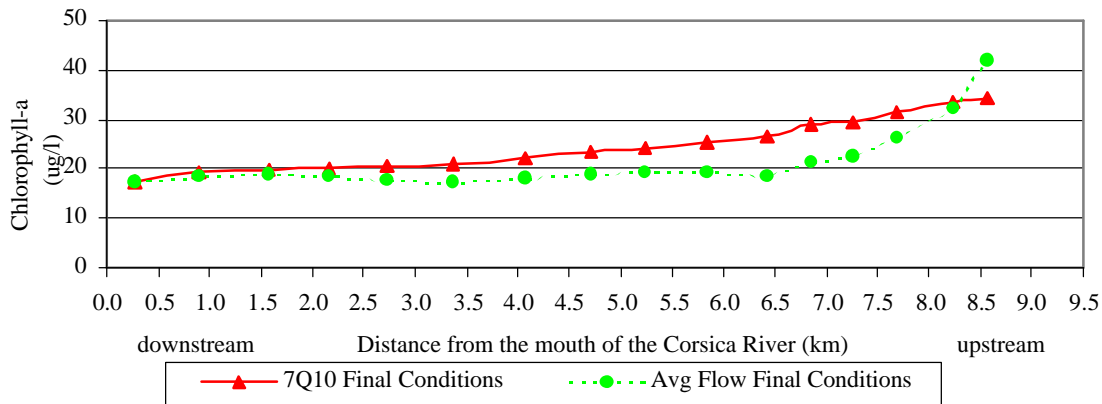

Figure A34: Chlorophyll-a vs River Kilometers for the Final Conditions Scenarios

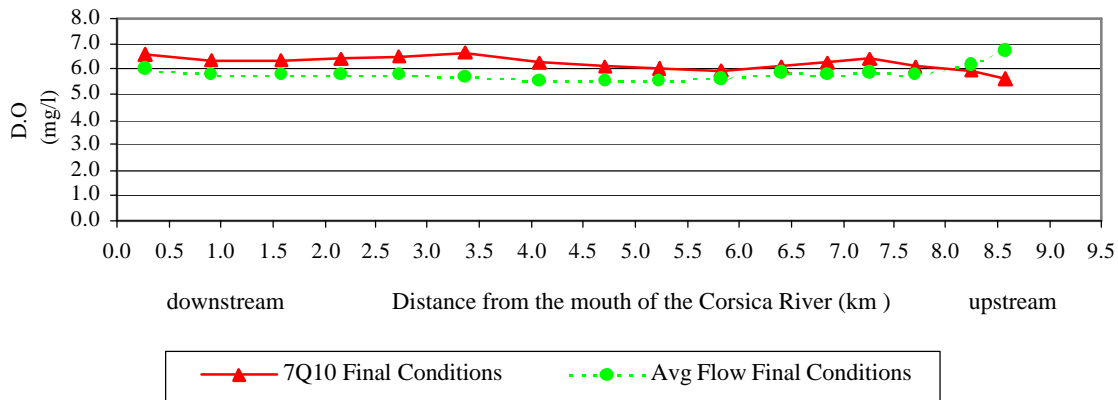

Figure A35: Dissolved Oxygen vs River Kilometers for the Final Conditions Scenarios

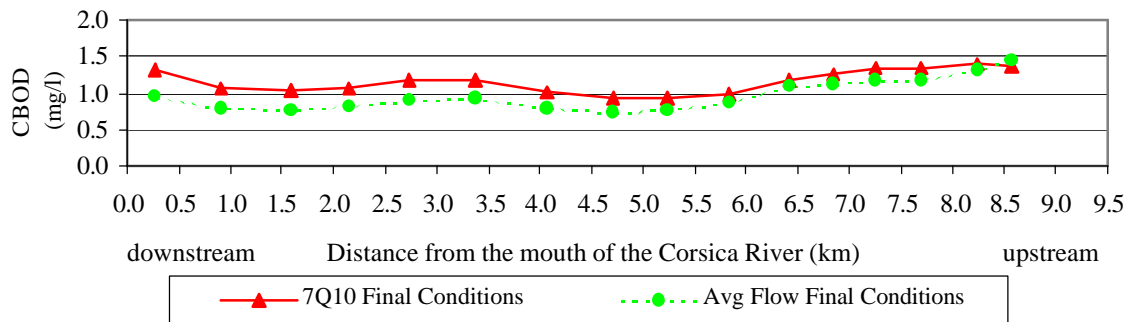

Figure A36: CBOD vs River Kilometers for the Final Conditions Scenarios

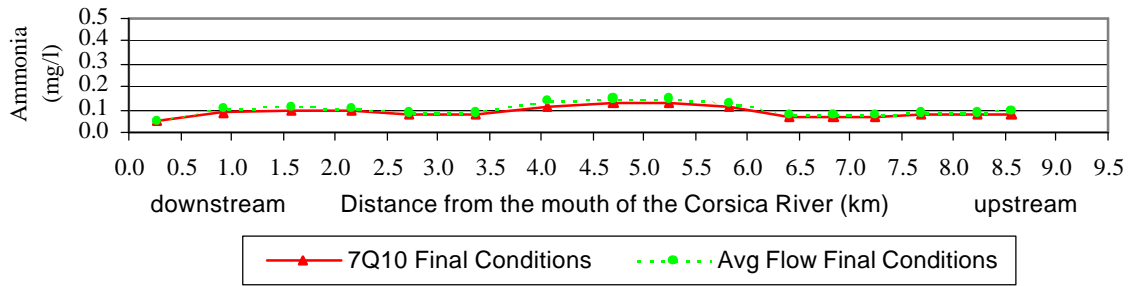

Figure A37: Ammonia vs River Kilometers for the Final Conditions Scenarios

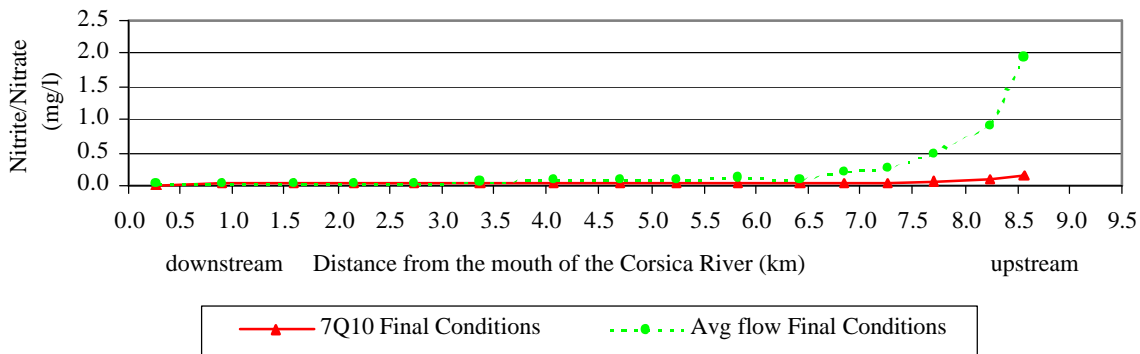

Figure A38: Nitrite/Nitrate vs River Kilometers for the Final Conditions Scenarios

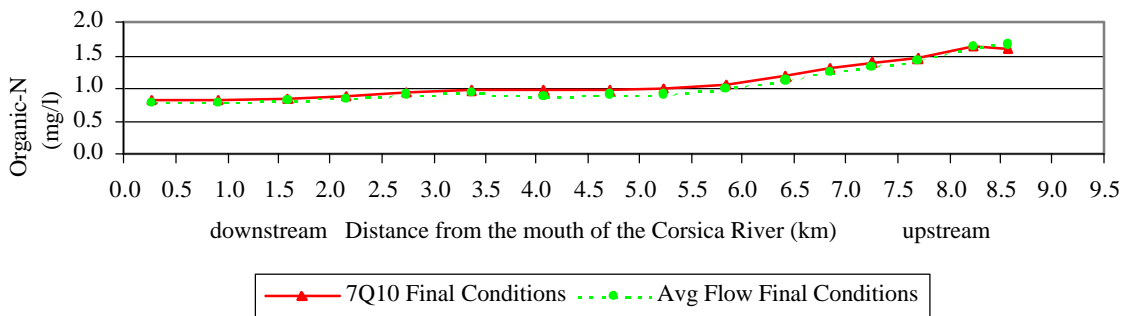

Figure A39: Organic Nitrogen vs River Kilometers for the Final Conditions Scenarios

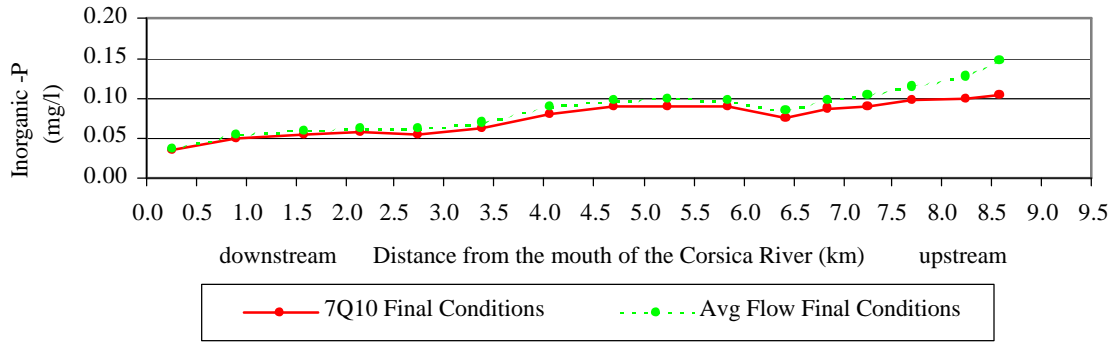

Figure A40: Inorganic Phosphorus vs River Kilometers for the Final Conditions Scenarios

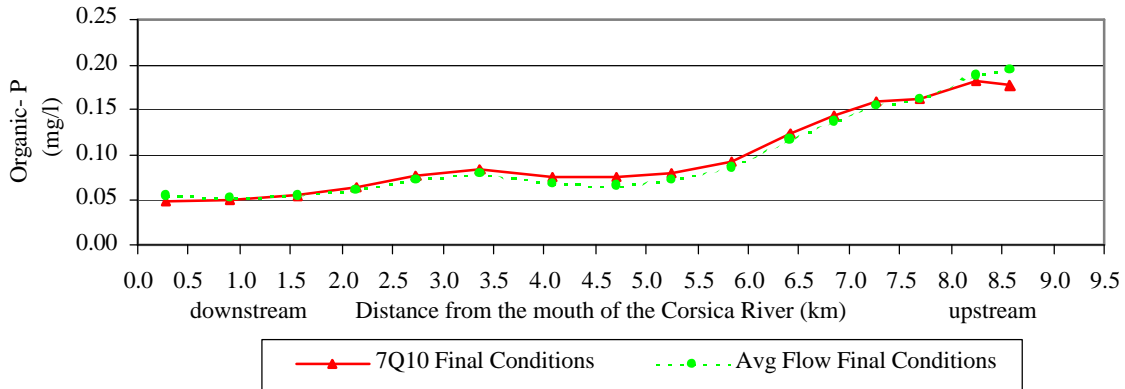

Figure A41: Organic Phosphorus vs River Kilometers for the Final Conditions Scenarios