

FINAL

**Total Maximum Daily Load of Phosphorus  
in the Double Pipe Creek Watershed,  
Frederick and Carroll Counties, Maryland**

**FINAL**



DEPARTMENT OF THE ENVIRONMENT  
1800 Washington Boulevard, Suite 540  
Baltimore, Maryland 21230-1718

Submitted to:

Watershed Protection Division  
U.S. Environmental Protection Agency, Region III  
1650 Arch Street  
Philadelphia, PA 19103-2029

August 2012

EPA Submittal Date: September 25, 2012  
EPA Approval Date: April 26, 2013

**Table of Contents**

**List of Figures..... i**

**List of Tables ..... i**

**EXECUTIVE SUMMARY ..... iv**

**1.0 INTRODUCTION..... 1**

**2.0 SETTING AND WATER QUALITY DESCRIPTION..... 3**

    2.1 General Setting ..... 3

        2.1.1 Land-Use ..... 5

    2.2 Source Assessment ..... 8

        2.2.1 Nonpoint Sources (NPS) Assessment ..... 8

        2.2.2 Point Source Assessment..... 10

        2.2.3 Overall Phosphorus Budget..... 11

    2.3 Water Quality Characterization ..... 12

        2.3.1 Biological Stressor Identification (BSID) Analysis ..... 16

        2.3.2 Dissolved Oxygen ..... 16

        2.3.3 Nutrients ..... 17

        2.3.4 Nutrient Limitation..... 18

        2.3.5 Double Pipe Creek Mainstem Benthic Macroinvertebrate Monitoring  
Stations ..... 19

    2.4 Water Quality Impairment..... 19

**3.0 TARGETED WATER QUALITY GOAL..... 21**

**4.0 TOTAL MAXIMUM DAILY LOADS AND SOURCE ALLOCATION..... 22**

    4.1 Overview..... 22

    4.2 Analysis Framework..... 22

    4.3 Scenario Descriptions and Results..... 24

    4.4 Critical Conditions and Seasonality..... 26

    4.5 TMDL Loading Caps..... 26

    4.6 Load Allocations Between Point and Nonpoint Sources..... 27

    4.7 Margin of Safety ..... 30

    4.8 Summary of Total Maximum Daily Loads..... 30

**5.0 ASSURANCE OF IMPLEMENTATION ..... 32**

**REFERENCES..... 35**

**APPENDIX A – Watershed Characterization Data ..... A-1**

**APPENDIX B – Technical Approach Used to Generate Maximum Daily Loads... B-1**

**APPENDIX C – Hydrologic Relationship between the Double Pipe Creek, Upper  
Monocacy River, and Lower Monocacy River Watersheds..... C-1**

**List of Figures**

Figure 1: Location Map of Double Pipe Creek in Frederick and Carroll Counties, Maryland..... 4

Figure 2: Landuse of the Double Pipe Creek Watershed..... 7

Figure 3: Monitoring Stations in the Double Pipe Creek Watershed ..... 15

Figure 4: Double Pipe Creek Dissolved Oxygen Data from 1998 through 2007 ..... 17

Figure 5: Double Pipe Creek Total Nitrogen Data from 1998 through 2007 ..... 18

Figure 6: Double Pipe Creek Total Phosphorus Data from 1998 through 2007..... 18

Figure B-1: Histogram of CBP River Segment Daily Phosphorus Simulation Results for the Double Pipe Creek Watershed ..... B-5

Figure C-1: Location of the Double Pipe Creek, Upper Monocacy River, and Lower Monocacy River Watersheds ..... C-2

Figure C-2: Flow Schematic of the Double Pipe Creek, Upper Monocacy River, and Lower Monocacy River Watersheds..... C-3

**List of Tables**

Table ES-1: MD 8-digit Double Pipe Creek Baseline Phosphorus Loads (lbs/yr)..... vii

Table ES-2: Average Annual MD 8-digit Double Pipe Creek TMDL of Phosphorus (lbs/yr)..... vii

Table ES-3: MD 8-Digit Double Pipe Creek Baseline Phosphorus Load, TMDL, and Total Reduction Percentage ..... vii

Table 1: Landuse Percentage Distribution for Double Pipe Creek Watershed..... 6

Table 2: Target EOS Loading Rates (lbs/ac/yr) By Landuse and County Land Segment.. 9

Table 3: 2009 Process Water Annual Phosphorus Loads (lbs/yr) for MD Facilities in Double Pipe Creek Watershed Represented in Phase 5.3.2 Watershed Model ..... 11

Table 4: Double Pipe Creek Watershed Detailed Baseline Total Phosphorus Loads..... 12

Table 5: MD 8-digit Double Pipe Creek Baseline Phosphorus Loads (lbs/yr)..... 12

Table 6: Monitoring Stations in the Double Pipe Creek Watershed..... 14

Table 7: Double Pipe Creek Mainstem DNR TREND Data..... 19

Table 8: Double Pipe Creek Watershed TMDL for Phosphorus ..... 27

Table 9: MD 8-digit Double Pipe Creek TMDL Phosphorus TMDL by Source Category ..... 30

Table 10: Average Annual MD 8-digit Double Pipe Creek TMDL of Phosphorus (lbs/yr) ..... 31

Table 11: MD 8-digit Double Pipe Creek Maximum Daily Load of Phosphorus (lbs/day) ..... 31

Table A-1: Reference Watersheds ..... A-1

Table B-1: Summary of Maximum Daily Loads of Total Phosphorus for the Double Pipe Creek Watershed (lbs/day)..... B-7

### List of Abbreviations

BIBI	Benthic Index of Biotic Integrity
BMP	Best Management Practices
BSID	Biological Stressor Identification
CAFO	Concentrated Animal Feeding Operation
CBLCD	Chesapeake Bay Watershed Land Cover Data
CBP P5.3.2	Chesapeake Bay Program Phase 5.3.2
CCAP	Coastal Change Analysis Program
cfs	Cubic Feet per Second
CFR	Code of Federal Regulations
COMAR	Code of Maryland Regulations
CNMP	Comprehensive Nutrient Management Plan
CSOs	Combined Sewer Overflows
CV	Coefficient of Variation
CWA	Clean Water Act
DMR	Discharge Monitoring Reports
DNR	Maryland Department of Natural Resources
ENR	Enhanced Nutrient Reduction
EOS	Edge-of-Stream
EPA	Environmental Protection Agency
EPSC	Environmental Permit Service Center
EPT	<i>Ephemeroptera, Plecoptera, and Trichoptera</i>
DO	Dissolved Oxygen
FIBI	Fish Index of Biologic Integrity
GIS	Geographic Information System
HSPF	Hydrological Simulation Program FORTRAN
IBI	Index of Biotic Integrity
LA	Load Allocation
lbs	Pounds
lbs/ac/yr	Pounds Per Acre Per Year
lbs/day	Pounds Per Day

lbs/yr	Pound Per Year
MACS	Maryland Agricultural Cost Share
MAFO	Maryland Animal Feeding Operation
MAL	Minimum Allowable Limit
MBSS	Maryland Biological Stream Survey
MDE	Maryland Department of the Environment
MDL	Maximum Daily Load
MGD	Millions of Gallons per Day
mg/l	Milligrams per liter
MOS	Margin of Safety
MRLC	Multi-Resolution Land Characteristics
MS4	Municipal Separate Stormwater System
NOI	Notice of Intent
NLCD	Consortium's National Land Cover Data
NOAA	National Oceanic and Atmospheric Administration
NPS	Nonpoint Source
NPDES	National Pollutant Discharge Elimination System
PCB	Polychlorinated biphenyls
PS	Point Source
PSI	Phosphorus Site Index
TMDL	Total Maximum Daily Load
TN	Total Nitrogen
TP	Total Phosphorus
USGS	United States Geological Survey
WIP	Watershed Implementation Plan
WLA	Waste Load Allocation
WQIA	Water Quality Improvement Act
WQLS	Water Quality Limited Segment
WWTP	Wastewater Treatment Plant

## EXECUTIVE SUMMARY

This document, upon approval by the U.S. Environmental Protection Agency (EPA), establishes a Total Maximum Daily Load (TMDL) for total phosphorus (TP) in the Double Pipe Creek watershed (basin number 02140304) (2010 *Integrated Report of Surface Water Quality in Maryland* Assessment Unit ID: MD-02140304). Section 303(d) of the federal Clean Water Act (CWA) and the EPA's implementing regulations direct each state to identify and list waters, known as water quality limited segments (WQLSs), in which current required controls of a specified substance are inadequate to achieve water quality standards. For each WQLS, the State is required to either establish a TMDL of the specified substance that the waterbody can receive without violating water quality standards, or demonstrate that water quality standards are being met (CFR 2011a).

The Maryland Department of the Environment (MDE) has identified the waters of Double Pipe Creek on the State's 303(d) List as impaired by nutrients (1996 listing), impacts to biological communities (2002 listing), and PCB in fish tissue (2008 listing) (MDE 2010a). All impairments are listed for non-tidal streams. Because scientific research supports that phosphorus is generally the limiting nutrient in freshwater aquatic systems, the 1996 nutrients listing was refined in the 2008 Integrated Report to identify phosphorus as the specific impairing substance (MDE 2008). Therefore, the listed impairment of phosphorus will henceforth be referred to in this report, and the term "nutrients" should be read as interchangeable with "phosphorus" in this case.

The designated use of Double Pipe Creek and its tributaries is Use I-P/Use III-P/Use IV-P (*Water Contact Recreation, Protection of Nontidal Warmwater Aquatic Life, and Public Water Supply; Water Contact Recreation, Protection of Nontidal Cold Water Aquatic Life and Public Water Supply; and Water Contact Recreation, Protection of Aquatic Life, Recreational Trout Waters and Public Water Supply*) (COMAR 2012a,b,c,d).

A data solicitation for nutrients was conducted by MDE in November 2009, and all readily available data from 1998 up to the time of the TMDL development have been considered. A TMDL for sediment was approved by the US EPA in 2008, and a TMDL for fecal coliform was approved by the US EPA in 2009. The listings for impacts to biological communities and PCB in fish tissue will be addressed separately at a future date.

The Double Pipe Creek watershed aquatic health scores, consisting of the Benthic Index of Biotic Integrity (BIBI) and Fish Index of Biotic Integrity (FIBI), indicate that the biological metrics for the watershed exhibit a significant negative deviation from reference conditions (Roth *et al.* 2005). The Biological Stressor Identification (BSID) analysis for the Double Pipe Creek watershed identified both phosphorus and nitrogen as potential stressors (MDE 2011). Both total phosphorus and orthophosphate show a significant association with degraded biological conditions. As much as 15% of the biologically impacted stream miles in the watershed are associated with high total phosphorus and 14% are associated with high orthophosphate. Similarly, according to

the BSID analysis, 65% of the biologically impacted stream miles in the Double Pipe Creek watershed are associated with high total nitrogen concentrations. An analysis of observed TN:TP ratios shows, however, that phosphorus is the limiting nutrient in Double Pipe Creek. Because nitrogen generally exists in quantities greater than necessary to sustain algal growth, excess nitrogen *per se* is not the cause of the biological impairment in Double Pipe Creek, and the reduction of nitrogen loads would not be an effective means of ensuring that the Double Pipe Creek watershed is free from impacts on aquatic life from eutrophication. Therefore, load allocations for the Double Pipe Creek Nutrient TMDL will apply only to total phosphorus.

The objective of this TMDL is to establish phosphorus loads that will be protective of the Aquatic Life Use designation for the Double Pipe Creek watershed. Currently in Maryland, there are no specific numeric criteria that quantify the impact of nutrients on the aquatic health of non-tidal stream systems; therefore, a reference watershed TMDL approach was used, which resulted in the establishment of a *phosphorus loading threshold*. This threshold is based on a detailed analysis of phosphorus loads from watersheds that are identified as supporting aquatic life (*i.e.*, reference watersheds) based on Maryland's biocriteria (Roth *et al.* 1998, 2000; Stribling *et al.* 1998; MDE 2008). This threshold is then used to determine a watershed specific phosphorus TMDL. The resulting loads are considered the maximum allowable loads the watershed can receive without causing any nutrient related impacts to aquatic health.

The computational framework chosen for the Double Pipe Creek watershed TMDL was the Chesapeake Bay Program Phase 5.3.2 (CBP P5.3.2) Watershed Model. The spatial domain of the CBP P5.3.2 Watershed Model segmentation aggregates to the Maryland 8-digit watersheds, which is consistent with the impairment listing.

EPA's regulations require TMDLs to take into account critical conditions for stream flow, loading, and water quality parameters (CFR 2011b). The premise of the reference watershed approach is that the reference watersheds are meeting water quality standards even under critical conditions. Therefore, the phosphorus loading rate derived from the reference watersheds protects water quality standards under critical conditions. Moreover, the loading rates used in the TMDL were determined using the Hydrological Simulation Program FORTRAN (HSPF) model, which is a continuous simulation model with a simulation period 1991-2000, thereby addressing annual changes in hydrology and capturing wet, average and dry years. The biological monitoring data used to determine the reference watersheds also integrates the stress effects over the course of time and thus inherently addresses critical conditions.

EPA's regulations also require TMDLs to be presented as a sum of waste load allocations (WLAs) for permitted point sources in the assessment unit and load allocations (LAs) for nonpoint sources generated within the assessment unit. In addition, TMDLs must account for natural background, tributary and adjacent segment loads. Finally, TMDLs must also include a margin of safety (MOS) to account for any lack of knowledge and uncertainty concerning the relationship between loads and water quality (CFR 2011a). Because the phosphorus loading threshold was conservatively based on the median

## FINAL

phosphorus loading rates from reference watersheds, Maryland has adopted an implicit MOS for nutrient TMDLs.

Biological results from both the Department of Natural Resources (DNR) CORE/TREND and Maryland Biological Stream Survey (MBSS) at a station on the Big Pipe Creek, the larger of the two main tributaries to Double Pipe Creek, and another station located just below the confluence of Big Pipe and Little Pipe Creeks indicate that mainstem water quality can be classified as Good to Good/Very Good. Based on this information, MDE concluded that the nutrient impairment in the Maryland portion of the Double Pipe Creek watershed is restricted to the lower order streams of the watershed.

The MD 8-digit Double Pipe Creek Total Baseline Phosphorus Load is 201,916 pounds per year (lbs/yr). The MD 8-digit Double Pipe Creek Watershed Baseline Load Contribution is further subdivided into nonpoint source baseline loads (Nonpoint Source BL) and three types of point source baseline loads: regulated Concentrated Animal Feeding Operations (CAFO), National Pollutant Discharge Elimination System (NPDES) regulated stormwater (NPDES Stormwater BL), and regulated process water (Process Water BL) (see Table ES-1). Phosphorus loads from septic systems are considered insignificant.

The MD 8-digit Double Pipe Creek Average Annual TMDL of Phosphorus is 128,328 lbs/yr. The MD 8-digit Double Pipe Creek TMDL Contribution is further subdivided into point and nonpoint source allocations and is comprised of a Load Allocation (LA) of 112,555 lbs/yr, a CAFO Wasteload Allocation (CAFO WLA) of 461 lbs/yr, an NPDES Stormwater Wasteload Allocation (NPDES Stormwater WLA) of 9,001 lbs/yr, and a Process Water Wasteload Allocation (Process Water WLA) of 6,310 lbs/yr (see Table ES-2).

In addition to the TMDL values, a Maximum Daily Load (MDL) for phosphorus is also presented in this document. The calculation of the MDL, which is derived from the TMDL average annual load, is explained in Appendix B and presented in Table B-1.

Overall, this TMDL will establish phosphorus loads that will be protective of the Use I-P/Use III-P/Use IV-P designations for the Double Pipe Creek watershed, and more specifically, these loads will be at a level the watershed can sustain without causing nutrient related impacts to aquatic health. The TMDL, however, will not completely resolve the impairment to biological communities within the watershed. Because the BSID watershed analysis identifies other possible stressors (*i.e.*, conductivity, inadequate riparian habitat, sediment-related stressors) as impacting the biological conditions, this impairment remains to be fully addressed through the Integrated Report listing process and the TMDL development process, such that all impairing substances identified as impacting biological communities in the watershed are reduced to levels that will meet water quality standards, as established in future TMDLs for those substances (MDE 2009a).



Once the EPA has approved this TMDL and it is known what measures must be taken to reduce pollution levels, implementation of best management practices (BMPs) are expected to take place. Section 303(d) of the Clean Water Act and current EPA regulations require reasonable assurance that the TMDL load and wasteload allocations can and will be implemented. The Double Pipe Creek phosphorus TMDL is expected to be implemented in a staged process. Reductions of nitrogen and phosphorus loads will be required to meet the Chesapeake Bay TMDL recently established by EPA (US EPA 2010a). These reductions are necessary to meet water quality standards to protect the designated uses of the Chesapeake Bay and its tidal tributaries, independent of any additional nutrient reductions that may be required to meet existing water quality standards designed to protect aquatic life in local non-tidal waterbodies.

MDE expects that the first stage of implementation of the Double Pipe Creek phosphorus TMDL shall be the achievement of the nutrient reductions needed within the Double Pipe Creek watershed in order to meet target loads consistent with the Chesapeake Bay TMDL, which is expected to be fully implemented in Maryland by 2025. Once the Bay TMDL nutrient target loads for the Double Pipe Creek watershed have been met, MDE will revisit the status of nutrient impacts on aquatic life in Double Pipe Creek, based on any additional monitoring data available and any improvements in the scientific understanding of the impacts of nutrients on aquatic life in free-flowing streams.

**Table ES-1: MD 8-digit Double Pipe Creek Baseline Phosphorus Loads (lbs/yr)**

MD 8-digit Double Pipe Creek Watershed Baseline Load Contribution										
Total Baseline Load (lbs/yr)	=	Nonpoint Source BL	+	Septic BL	+	CAFO BL	+	NPDES Stormwater BL	+	Process Water BL
201,916	=	164,842	+	0	+	1,001	+	25,133	+	10,940

**Table ES-2: Average Annual MD 8-digit Double Pipe Creek TMDL of Phosphorus (lbs/yr)**

TMDL (lbs/yr)	=	LA		+	WLA			+	MOS			
	=	LA	+	Septic	+	CAFO WLA	+	NPDES Stormwater WLA		+	Process Water WLA	
128,328	=	112,555	+	0	+	461	+	9,001	+	6,310	+	Implicit

**Table ES-3: MD 8-Digit Double Pipe Creek Baseline Phosphorus Load, TMDL, and Total Reduction Percentage**

Baseline Load (lbs/yr)	TMDL (lbs/yr)	Total Reduction (%)
201,916	128,328	36%

FINAL

## 1.0 INTRODUCTION

This document, upon approval by the U.S. Environmental Protection Agency (EPA), establishes a Total Maximum Daily Load (TMDL) for total phosphorus (TP) in the Double Pipe Creek watershed (basin number 02140304) (2010 *Integrated Report of Surface Water Quality in Maryland* Assessment Unit ID: MD-02140304). Section 303(d)(1)(C) of the federal Clean Water Act (CWA) and the EPA's implementing regulations direct each state to develop a TMDL for each impaired water quality limited segment (WQLS) on the Section 303(d) List, taking into account seasonal variations, critical conditions, and a protective margin of safety (MOS) to account for uncertainty (CFR 2011a). A TMDL reflects the total pollutant loading of the impairing substance a waterbody can receive and still meet water quality standards.

TMDLs are established to determine the pollutant load reductions needed to achieve and maintain water quality standards. A water quality standard is the combination of a designated use for a particular body of water and the water quality criteria designed to protect that use. Designated uses include activities such as swimming, drinking water supply, protection of aquatic life, and shellfish propagation and harvest. Water quality criteria consist of narrative statements and numeric values designed to protect the designated uses. Criteria may differ among waters with different designated uses.

The Maryland Surface Water Use Designation in the Code of Maryland Regulations (COMAR) for the waters of Double Pipe Creek is Use I-P (*Water Contact Recreation, Protection of Nontidal Warm Water Aquatic Life, and Public Water Supply*). One tributary, Bear Branch (and its tributaries) from the stream's confluence with Bennett Creek is designated as Use III-P (*Water Contact Recreation, Protection of Nontidal Cold Water Aquatic Life, and Public Water Supply*). The remaining tributaries of Double Pipe Creek include Big Pipe Creek, Little Pipe Creek, Meadow Branch and Sam's Creek are designated as Use IV-P (*Water Contact Recreation, Protection of Aquatic Life, Recreational Trout Waters and Public Water Supply*) (COMAR 2012a,b,c,d).

The Maryland Department of the Environment (MDE) has identified the waters of Double Pipe Creek on the State's 303(d) List as impaired by nutrients (1996 listing), impacts to biological communities (2002 listing), and PCB in fish tissue (2008 listing) (MDE 2010a). All impairments are listed for non-tidal streams. Because scientific research supports that phosphorus is generally the limiting nutrient in freshwater aquatic systems, the 1996 nutrient listing was refined in the 2008 Integrated Report to identify phosphorus as the specific impairing substance (MDE 2008). Therefore, the listed impairment of phosphorus will henceforth be referred to in this report, and the term "nutrients" should be read as interchangeable with "phosphorus" in this case.

A data solicitation for nutrients was conducted by MDE in November 2009, and all readily available data from 1998 up to the time of the TMDL development have been considered. A TMDL for sediment was approved by the US EPA in 2008, and a TMDL for fecal coliform was approved by the US EPA in 2009. The listings for impacts to biological communities and PCBs in fish tissue will be addressed separately at a future date.

The objective of this TMDL is to establish phosphorus loads that will be protective of the Aquatic Life Use designation for the Double Pipe Creek watershed. A Biological Stressor Identification (BSID) analysis of Double Pipe Creek (MDE 2011) shows phosphorus is associated with biological impairments in the Double Pipe Creek watershed, confirming the original 1998 listing; therefore, a TMDL will be established for phosphorus.

Currently in Maryland, there are no specific numeric criteria that quantify the impact of phosphorus on the aquatic health of non-tidal stream systems; therefore, a reference watershed TMDL approach was used, which resulted in the establishment of a *phosphorus loading threshold*. This threshold is based on a detailed analysis of phosphorus loads from watersheds that are identified as supporting aquatic life (*i.e.*, reference watersheds) based on Maryland's biocriteria (Roth *et al.* 1998, 2000, Stribling *et al.* 1998, MDE 2010a). This threshold is then used to determine a watershed specific phosphorus TMDL. The Chesapeake Bay Program's (CBP) Phase 5.3.2 Watershed Model (P5.3.2) is used to determine the nutrient loads in both Double Pipe Creek and the reference watersheds that will be used to set the nutrient TMDL for Double Pipe Creek.

## 2.0 SETTING AND WATER QUALITY DESCRIPTION

### 2.1 General Setting

#### Location

The Double Pipe Creek watershed is located within Frederick and Carroll Counties, Maryland (Figure 1) and encompasses approximately 193 square miles. The watershed consists of two sub-basins: Big Pipe Creek, which makes up 58% of the total watershed area, and Little Pipe Creek, which makes up the remaining 42% (McCoy and Summers 1992). These branches are free-flowing (non-tidal) streams that conjoin to form Double Pipe Creek. Double Pipe Creek discharges into the Monocacy River at Rocky Ridge MD, which eventually empties into the Middle Potomac River near the town of Dickerson, MD.

The watershed is mostly rural consisting primarily of crop land and forest. There are several minor urban areas within the basin, including Taneytown, Manchester, Union Bridge, and New Windsor, and one major urban area, the city of Westminster.

Because the Double Pipe Creek stream system empties into the Maryland 8-Digit (MD 8-Digit) Upper Monocacy River watershed, loads generated within the Double Pipe Creek watershed impact downstream conditions within the mainstem of the MD 8-Digit Upper Monocacy River watershed. The hydrological relationship between the watersheds is further explained in Appendix C.

#### Geography/Soils

The Double Pipe Creek watershed lies within the north central Piedmont Plateau Physiographic Province of Maryland. It is characterized by gently rolling to steep uplands with streams of average to steep gradients, which drain in a southerly direction into the lower valleys of the Piedmont (MDE 2007b). The predominant soils in the watershed are moderately erodible. Crystalline igneous and metamorphic rocks of volcanic origin consisting primarily of schist and gneiss characterize the surficial geology of the watershed (Edwards 1981). Ground water within the project area occurs primarily in fractures and bedding-plane partings of rocks. It may also occur in solutional cavities in limestone and marble (McCoy and Summers 1992). The Double Pipe Creek watershed lies predominantly in the Baile soil series. Soils in this series are fine-loamy, mixed, mesic Typic Ochraquults and are very deep and poorly drained soils (MGS 2007).

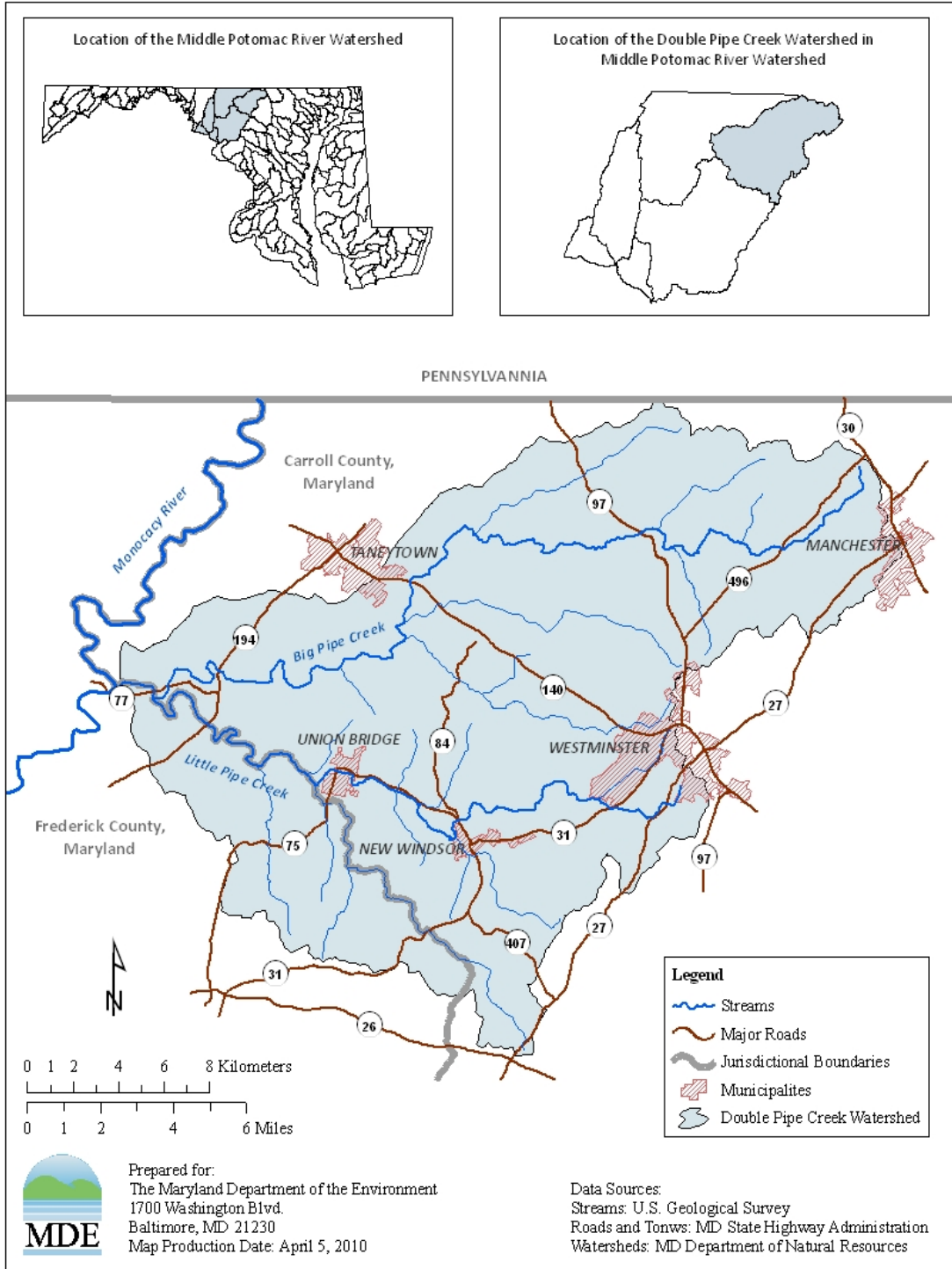

**Figure 1: Location Map of Double Pipe Creek in Frederick and Carroll Counties, Maryland**

### 2.1.1 Land-Use

#### Landuse Methodology

The landuse framework used to develop this TMDL was originally developed for the Chesapeake Bay Program Phase 5.3.2 (CBP P5.3.2) watershed model.<sup>1</sup> The CBP P5.3.2 landuse was based on two distinct stages of development.

The first stage consists of the development of the Chesapeake Bay Watershed Land Cover Data (CBLCD) series of Geographic Information System (GIS) datasets. These datasets provide a 30-meter resolution raster representation of land cover in the Chesapeake Bay watershed, based on sixteen Anderson Level 2 land cover classes. The CBLCD basemap, representing 2001 conditions, was primarily derived from the Multi-Resolution Land Characteristics (MRLC) Consortium's National Land Cover Data (NLCD) and the National Oceanic and Atmospheric Administration's (NOAA) Coastal Change Analysis Program's (CCAP) Land Cover Data. By applying Cross Correlation Analysis to Landsat 5 Thematic Mapper and Landsat 7 Enhanced Thematic Mapper satellite imagery, USGS's contractor, MDA Federal, generated CBLCD datasets for 1984, 1992, and 2006 from the 2001 baseline dataset. The "*Chesapeake Bay Phase 5.3 Community Watershed Model*" (US EPA 2010b) describes the development of the CBLCD series in more detail. USGS and NOAA also developed an impervious cover dataset from Landsat satellite imagery for the CBLCD basemap, which was used to estimate the percent impervious cover associated with CBLCD developed landuse classes.

The second stage consists of using ancillary information for: 1) the creation of a modified 2006 CBLCD raster dataset and 2) the subsequent development of the CBP P5.3.2 landuse framework in tabular format. Estimates of the urban footprint in the 2006 CBLCD were extensively modified using supplemental datasets. NAVTEQ street data (secondary and primary roads) and institutional delineations were overlaid with the 2006 CBLCD land cover and used to reclassify underlying pixels. Certain areas adjacent to the secondary road network were also reclassified based on assumptions developed by USGS researchers, in order to capture residential development (*i.e.*, subdivisions not being picked up by the satellite in the CBLCD). In addition to spatially modifying the 2006 CBLCD, the following datasets were used to supplement the developed land cover data in the final CBP P5.3.2 landuse framework: U.S. Census housing unit data, Maryland Department of Planning (MDP) Property View data, and estimates of impervious coefficients for rural residential properties (determined via a sampling of these properties using aerial photography). This additional information was used to estimate the extent of impervious area in roadways and residential lots. Acres of construction and extractive land uses were determined independently (Claggett *et al.* 2012). Finally, in order to develop accurate agricultural landuse acreages, the CBP P5.3.2 incorporated county-level U.S. Agricultural Census data (USDA 1982, 1987, 1992, 1997, 2002, 2007). The "*Chesapeake Bay Phase*

---

<sup>1</sup> The EPA Chesapeake Bay Program developed the first watershed model in 1982. There have been many upgrades since the first phase of this model. The latest version, CBP Phase 5.3.2 was developed to estimate flow, nutrients, and sediment loads to the Bay.

5.3 Phase 5.3 Community Watershed Model” (US EPA 2010b) describes these modifications in more detail.

The result of these modifications is that CBP P5.3.2 landuse does not exist in a single GIS coverage; instead it is only available in a tabular format. The CBP P5.3.2 watershed model is comprised of 30 land uses. Within each general landuse type, most of the subcategories of land uses are differentiated only by their nitrogen and phosphorus loading rates. Table 1 summarizes the acreage of CBP P5.3.2 by sector in the Double Pipe Creek watershed. The landuse acreage is based on the CBP P5.3.2 2009 Progress Scenario, which, for the CBP P5.3.2 model, represents current conditions.

### **Double Pipe Creek Watershed Landuse Distribution**

The landuse distribution in the Double Pipe Creek watershed consists mostly of crop land (44.2%) and forest (30.9%), followed by regulated urban land (16.4%) and pasture (8.1%). A summary of the watershed landuse areas is presented in Table 1 and a landuse map is provided in Figure 2.

**Table 1: Landuse Percentage Distribution for Double Pipe Creek Watershed**

<b>General Land-Use</b>	<b>Detailed Land-Use</b>	<b>Area (Acres)</b>	<b>Percent (%)</b>	<b>Grouped Percent of Total</b>
Forest	Forest	37,725	30.6%	30.9%
	Harvested Forest	379	0.3%	
AFOs	Animal Feeding Operations	105	0.1%	0.1%
CAFOs	Concentrated Animal Feeding Operations	25	< 0.1	< 0.1
Pasture	Pasture	10,024	8.1%	8.1%
Crop	Crop	54,565	44.2%	44.2%
Nursery	Nursery	260	0.2%	0.2%
Regulated Urban	Regulated Construction	443	0.4%	16.4%
	Regulated Developed	19,442	15.8%	
	Regulated Extractive	384	0.3%	
Water	Water	38	< 0.1	< 0.1
<b>Total</b>		<b>123,390</b>	<b>100.0%</b>	<b>100.0%</b>



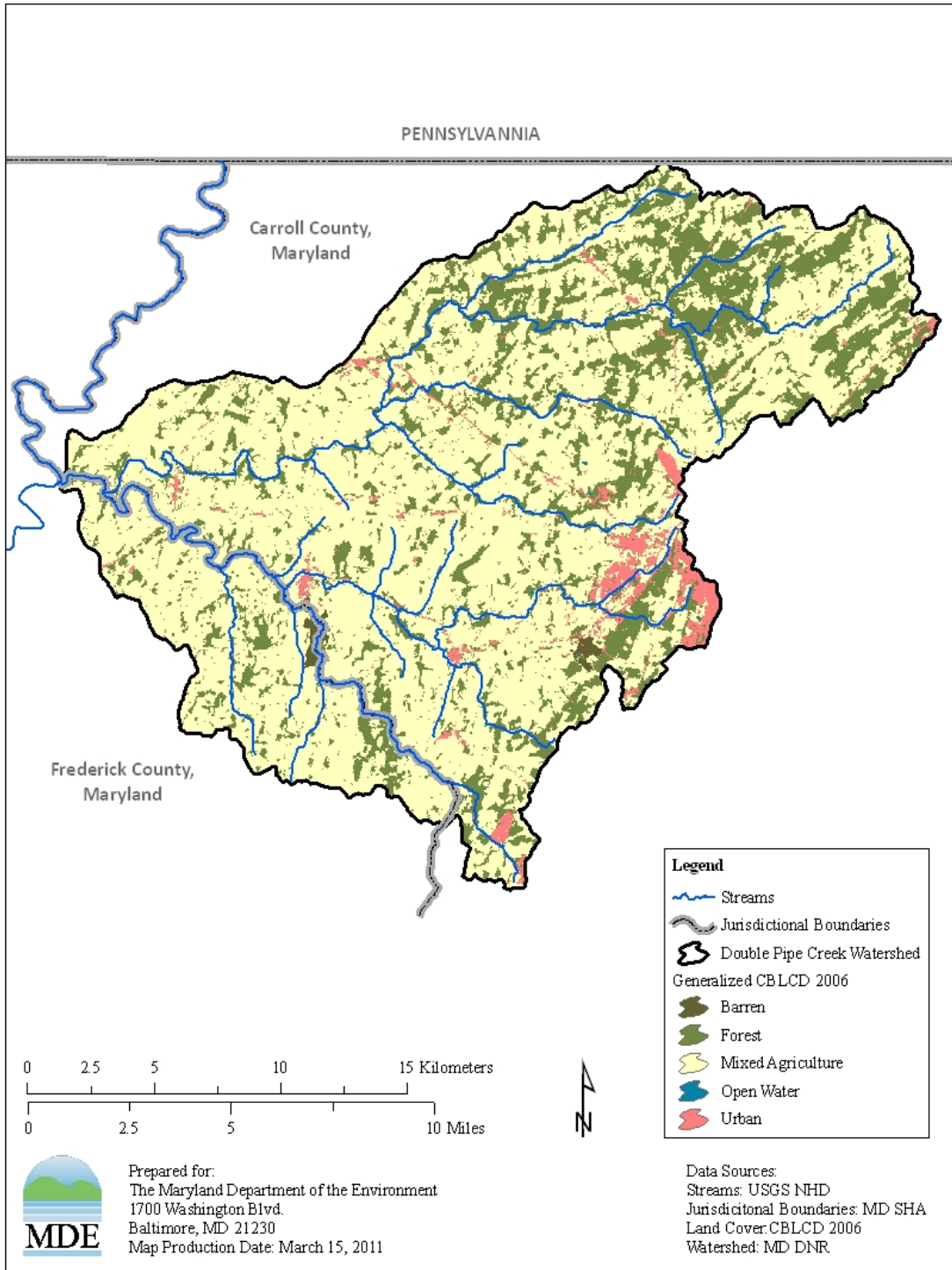

**Figure 2: Landuse of the Double Pipe Creek Watershed**

## 2.2 Source Assessment

### 2.2.1 Nonpoint Sources (NPS) Assessment

Nonpoint source nutrient loads in the Double Pipe Creek watershed are estimated based on the edge-of-stream (EOS) loading rates from the CBP P5.3.2 Model 2009 Progress Scenario. The 2009 Progress Scenario is a simulation of nutrient loading to the creek, using as inputs current land use, BMP implementation and estimated loading rates, precipitation and other meteorological data from the period 1991 – 2000, thereby addressing annual changes in hydrology and capturing wet, average and dry years. The period 1991-2000 is the baseline hydrological period for the Chesapeake Bay TMDL.

EOS loads in the P5.3.2 model are determined by three factors: (1) the median of land-use-specific loading rates found in the scientific literature; (2) the adjustment of the median loading rate based on the excess nutrient inputs applied to agricultural land uses to determine EOS targets by land segment and land-use; and (3) the application of regional factors in the river calibration.

#### Literature Review

Using Beaulac and Reckhow's (1982) literature survey as a starting point, CBP staff conducted a survey of the scientific literature to determine the range of observed nutrient loading rates from land uses. Most of these estimates were made from observations on small, homogeneous watersheds and thus represent edge-of-stream, rather than edge-of-field, nutrient loads. Phosphorus loads for developed land uses are based on the median phosphorus concentration in urban stormwater determined by Pitt *et al.* (2005) in their study of monitoring data collected by jurisdictions for their Municipal Separate Storm Sewer System (MS4) permits. See "*Chesapeake Bay Phase 5.3 Community Watershed Model*" (US EPA 2010b) for further discussion of loading rates found in the scientific literature.

#### EOS Calibration Targets

Land processes in the P5.3.2 model are simulated by landuse and land segment. Land segments are counties or, in some cases, sections of counties where precipitation is expected to vary because of orographic uplift.

The median literature loading rate is the starting point for determining calibration targets for EOS loads in the P5.3.2 model. For developed land uses, the target load is the product of average annual simulated runoff in the land segment and the median phosphorus concentration in urban stormwater, 0.27 mg/l, as determined by Pitt *et al.* (2005). For agricultural land uses, median rates were adjusted upwards or downwards depending on how much of the amount of nutrients applied to a landuse in a land segment exceeded the needs of the vegetation on that landuse, compared to the average Chesapeake Bay segment. In other words, land segment calibration targets were distributed around the median literature values in proportion to the excess nutrients applied to the segments.

CBP calculated the nutrient loading rates for manure, fertilizer, and atmospheric deposition, as well as crop and vegetative uptake, for each landuse and land segment. These calculations were based on the agricultural census, the expert opinion of local and state agronomists, statistics on fertilizer sales, and a mass balance of animal waste based on animal population estimates. See “*Chesapeake Bay Phase 5.3 Phase 5.3 Community Watershed Model*” (US EPA 2010b) for further details on the calculation of loading rates. For land uses with nutrient management, EOS loads are determined by reducing nutrient inputs to their agronomic rates on the corresponding landuse without nutrient management.

Table 2 gives the TP EOS targets for non-nutrient management land uses.

**Table 2: Target EOS Loading Rates (lbs/ac/yr) By Landuse and County Land Segment**

<b>Land-Use</b>	<b>Carroll County CBP Land Segment A24013</b>	<b>Frederick County CBP Land Segment A24021</b>
Forest	0.11	0.10
Harvested Forest	0.80	0.80
Degraded Riparian Pasture	13.35	14.77
Pasture	1.11	1.23
Alfalfa	0.70	0.70
Hay Without Nutrients	0.40	0.40
Hay With Nutrients	0.72	0.64
High Till Without Manure	2.70	2.69
High Till With Manure	2.02	2.00
Low Till With Manure	2.01	1.99
Nursery	85.00	85.00
Regulated Extractive	3.50	3.50
Regulated Construction	7.00	7.00
Regulated Impervious Developed	2.14	2.04
Regulated Pervious Developed	0.51	0.48

Nutrient simulations for specific land uses are calibrated against these targets on a per acre basis over the simulation period 1985-2005. The phosphorus loads from these simulations are multiplied by a time-variable representation of the landuse acreage in each watershed, and the impact of changing levels of BMP implementation are also simulated over the 21-year calibration period. The resulting loads are used as the initial EOS inputs to the river simulation. During the calibration of the river simulation, the EOS loads are adjusted by regional factors, as explained below.

### **Regional Factors**

The use of literature loading rates and their adjustment according to the excess nutrients applied to the land can be expected to provide a good estimate of landuse loading rates relative to each other. To further reduce uncertainty in loading rates, CBP applies a multiplicative regional factor to the simulated land segment loading rate. Regional factors

are calculated in the calibration of river segments, where simulated output is compared to observed monitoring data.

Regional factors are calculated on a river segment basis. For all river segments in Double Pipe Creek, the regional factor for phosphorus is 1.436.

### **2.2.2 Point Source Assessment**

A list of active permitted point sources that contribute to the phosphorus load in the Double Pipe Creek watershed was compiled using MDE's permits database. The types of permits identified include individual industrial, individual municipal, general mineral mining, general industrial stormwater, general municipal separate storm sewer systems (MS4s) and general Concentrated Animal Feeding Operations (CAFOs).

The types of NPDES permits can be grouped into three categories: (1) process water, (2) stormwater, and (3) CAFOs. In turn, process water permits can be divided into permits for municipal wastewater treatment plants (WWTPs) and permits for industrial facilities. Permits for major municipal WWTPs (i.e. WWTPs with design flow equal or larger than 0.5 MGD are considered major) contain flow and TP limits; their current nutrient loads are calculated from discharge monitoring reports (DMR) data. There are six municipal wastewater treatment plants (WWTPs) in the Double Pipe Creek watershed. The largest facility - Westminster WWTP (MD0021831) is slated to receive enhanced nutrient removal technologies under Maryland's Enhanced Nutrient Removal (ENR) strategy, which provides grant funds to local governments to retrofit or upgrade WWTPs. The remaining process water facilities in the watershed are minor municipal and industrial facilities, which have smaller flows and consequently smaller nutrient loads. There are six minor industrial facilities capable of discharging phosphorus. Baseline phosphorus loads for minor municipal WWTPs are based on DMR data, while current loads for minor industrial facilities were based either from monitoring required by their permits or professional judgment.

Table 3 lists the process-water facilities with active permits within the Double Pipe Creek watershed and their estimated baseline loads. The load for the major municipal facility is given on an individual basis. The loads for all minor municipal and industrial facilities in the watershed are presented as one aggregate load. All these facilities with their estimated loads are represented in the Phase 5.3.2 Watershed Model 2009 Progress Scenario. The total estimated 2009 MD process water TP load is 10,940 lbs/yr.

**Table 3: 2009 Process Water Annual Phosphorus Loads (lbs/yr) for MD Facilities in Double Pipe Creek Watershed Represented in Phase 5.3.2 Watershed Model**

NPDES Permit #	Facility Name	TYPE		TP Load (lb/yr)
		Municipal	Individual	
MD0021831	WESTMINSTER WWTP	Municipal	Individual	8,319
MD0022454	UNION BRIDGE WWTP	Municipal		
MD0022586	NEW WINDSOR WWTP			
MD0066745	PLEASANT VALLEY WWTP			
MD0065927	RUNNYMEDE WWTP			
MD0067571	BOWLING BROOK PREPARATORY SCHOOL			
MDG915060	SHEETZ STORE #177	Industrial	Aggregate	2,621
MDG490226	LAFARGE - MEDFORD QUARRY			
MDG492448	LEHIGH CEMENT COMPANY – NEW WINDSOR QUARRY			
MDG498000	MEDFORD QUARRY (REICHLIN TRACT)			
MDG490433	THOMAS, BENNETT & HUNTER, INC. – WESTMINSTER CONCRETE			
MDG499720	STAMBAUGH'S INCORPORATED			
MD0000779	LEHIGH CEMENT COMPANY - UNION BRIDGE			
<b>Total</b>				<b>10,940</b>

In Maryland's jurisdictions with Phase I and/or Phase II MS4 permits, all urban stormwater from developed land is regulated under the NPDES MS4 program. These urban stormwater loads are calculated using the developed landuse in the watershed. The stormwater permits do not include nutrient limits, but are regulated instead based on programmatic approaches. The total MD urban stormwater TP load is 25,133 lbs/yr.

Starting in 2009, Maryland began the process of permitting Concentrated Animal Feeding Operations (CAFOs). CAFOs are medium to large animal feeding operations that have some artificial conveyance like a swale or ditch to discharge runoff from feedlots to surface water. Recent EPA regulations require CAFOs to have a NPDES permit. Maryland also designates large animal feeding operations which do not discharge or propose to discharge as "Maryland Animal Feeding Operations" (MAFOs). It is anticipated that on review many MAFOs will require CAFO permits.

Several operators in the Double Pipe Creek watershed have filed notices of intent (NOI) to apply for permits under Maryland's CAFO or MAFO regulations. Based on the NOIs filed by the reporting deadline of February, 2009, CBP estimates that the current average annual phosphorus load from CAFOs in the Double Pipe Creek watershed is 1,001 lbs/yr.

### 2.2.3 Overall Phosphorus Budget

Table 4 lists the current overall phosphorus budget for the Double Pipe Creek watershed. These loads are derived from the P5.3.2 2009 Progress Scenario, described above. The largest source of phosphorus is crop land (51.7%). Other phosphorus sources include nurseries (16.9%), regulated urban land (12.4%), pasture (8.4%), point sources (5.4%),

forest (2.9%), and unregulated animal feeding operations and CAFOs (2.3%). There are no combined sewer overflows (CSOs) in the Double Pipe Creek watershed, and phosphorus loads from septic systems are considered insignificant. Table 5 summarizes the MD 8-digit Double Pipe Creek Baseline Phosphorus Load, reported in pounds per year (lbs/yr) and presented in terms of MD 8-digit Double Pipe Creek Watershed Baseline Load Contribution nonpoint and point source loadings.

**Table 4: Double Pipe Creek Watershed Detailed Baseline Total Phosphorus Loads**

General Land-Use	Detailed Land-Use	Load (lbs/yr)	Percent (%)	Grouped Percent of Total
Forest	Forest	5,463	2.7%	2.9%
	Harvested Forest	329	0.2%	
AFOs	Animal Feeding Operations	3,646	1.8%	1.8%
CAFOs	Concentrated Animal Feeding Operations	1,001	0.5%	0.5%
Pasture	Pasture	16,862	8.4%	8.4%
Crop	Crop	104,445	51.7%	51.7%
Nursery	Nursery	34,073	16.9%	16.9%
Regulated Urban	Regulated Construction	2,911	1.4%	12.4%
	Regulated Developed	20,051	9.9%	
	Regulated Extractive	2,171	1.1%	
Septic	Septic	0	0%	0%
CSO	CSO	0	0%	0%
Point Sources	Industrial Point Sources	3	< 0.1%	5.4%
	Municipal Point Sources	10,937	5.4%	
Atmospheric Deposition	Non-tidal Atmospheric Deposition	24	< 0.1%	< 0.1
<b>Total</b>		<b>201,916</b>	<b>100.0%</b>	<b>100.0%</b>

**Table 5: MD 8-digit Double Pipe Creek Baseline Phosphorus Loads (lbs/yr)**

MD 8-digit Double Pipe Creek Watershed Baseline Load Contribution										
Total Baseline Load (lbs/yr)	=	Nonpoint Source BL	+	Septic BL	+	CAFO BL	+	NPDES Stormwater BL	+	Process Water BL
201,916	=	164,842	+	0	+	1,001	+	25,133	+	10,940

### 2.3 Water Quality Characterization

The Double Pipe Creek watershed was originally listed on Maryland’s 1996 303(d) List as impaired by nutrients. The listing implied that the nutrient impairment was based on the watershed’s contribution to the impairment of the Chesapeake Bay. (MDE 2004, DNR 1996).

## FINAL

A water quality standard is the combination of a designated use for a particular body of water and the water quality criteria designed to protect that use. Designated uses include support of aquatic life, primary or secondary contact recreation, drinking water supply, and shellfish propagation and harvest. Water quality criteria consist of narrative statements and numeric values designed to protect the designated uses. The criteria developed to protect the designated use may differ and are dependent on the specific designated use(s) of a waterbody.

The Maryland water quality standards surface water use designation for the Double Pipe Creek mainstem and its tributaries is Use I-P/Use III-P/Use IV-P (*Water Contact Recreation, Protection of Nontidal Warm Water Aquatic Life and Public Water Supply; Water Contact Recreation, Protection of Nontidal Cold Water Aquatic Life and Public Water Supply; Water Contact Recreation, Protection of Aquatic Life and Recreational Trout Waters and Public Water Supply*) (COMAR 2012a,b,c,d).

Currently, there are no specific numeric criteria for nutrients in Maryland's water quality standards for the protection of aquatic life in free-flowing non-tidal waters. MDE has developed a biological stressor identification (BSID) analysis to identify potential stressors of aquatic life, including nutrients, in 1<sup>st</sup> through 4<sup>th</sup> order streams assessed by the Maryland Biological Stream Survey (MBSS). The impact of eutrophication on smaller-order streams in the watershed will be evaluated on the basis of the BSID analysis, which provides necessary and sufficient conditions for determining whether phosphorus is a potential stressor of the biological community in smaller-order streams.

Low levels of dissolved oxygen are sometimes associated with the decay of excess primary production and therefore nutrient over-enrichment. The dissolved oxygen (DO) concentration to protect Use I-P waters "may not be less than 5 milligrams per liter (mg/l) at any time" and to protect Use III-P waters "may not be less than 5 mg/l at any time, with a minimum daily average of not less than 6 mg/l" (COMAR 2012e).

A data solicitation was conducted by MDE in November 2009 and all readily available data from 1998 up to the time of the TMDL development were considered. MDE collected water quality data in the Double Pipe Creek watershed from October 2001 through November 2005. DNR collected water quality data for the CORE/TREND network between January 1998 and June 2007 and for the MBSS program in March 2002. Figures 4 through 7 provide graphical representation of the collected data for the parameters discussed below.

### **Double Pipe Creek Watershed Monitoring Stations**

A total of 31 stations were monitored in the Double Pipe Creek watershed for water quality by MDE and DNR's MBSS and CORE/TREND programs between 1998 and 2007. Two of these stations, BPC0035 and DPC001, were monitored by both MDE and DNR. Of these 31 stations, 15 were sampled during the growing season, May 1 through October 31. The stations are listed in Table 6 and presented in Figure 3.

**Table 6: Monitoring Stations in the Double Pipe Creek Watershed.**

<b>Station ID</b>	<b>Sponsor</b>	<b>Program</b>	<b>Latitude (dec. degrees)</b>	<b>Longitude (dec. degree)</b>	<b>Stream Name</b>
BEB0009	MDE	Water Quality	39.635500	-77.128200	Bear Branch
BPC0006	MDE	Water Quality	39.606000	-77.263150	Big Pipe Creek
BPC0035	MDE	Water Quality	39.612250	-77.236720	Big Pipe Creek
BPC0092	MDE	Water Quality	39.616883	-77.168717	Big Pipe Creek
BPC0120	MDE	Water Quality	39.640380	-77.138400	Big Pipe Creek
BPC0137	MDE	Water Quality	39.657180	-77.121120	Big Pipe Creek
BPC0213	MDE	Water Quality	39.662020	-77.008750	Big Pipe Creek
DPC0013	MDE	Water Quality	39.603900	-77.270150	Double Pipe Creek
LPC0032	MDE	Water Quality	39.591070	-77.242670	Little Pipe Creek
LPC0087	MDE	Water Quality	39.568680	-77.189570	Little Pipe Creek
LPC0091	MDE	Water Quality	39.568830	-77.184020	Little Pipe Creek
LPC0132	MDE	Water Quality	39.549980	-77.127800	Little Pipe Creek
LPC0193	MDE	Water Quality	39.561550	-77.044100	Little Pipe Creek
LPC0199	MDE	Water Quality	39.557880	-77.033350	Little Pipe Creek
MEB0000	MDE	Water Quality	39.625333	-77.140900	Meadow Branch
BPC0035	DNR	TREND	39.612250	-77.236720	Big Pipe Creek
DPC0013	DNR	TREND	39.603900	-77.270150	Double Pipe Creek
DOUB-101-R-2002	DNR	MBSS	39.615181	-77.109861	Meadow Branch UT1
DOUB-103-R-2002	DNR	MBSS	39.652030	-77.055723	Big Pipe Creek UT8
DOUB-109-R-2002	DNR	MBSS	39.610036	-77.265576	Big Pipe Creek UT5
DOUB-113-R-2002	DNR	MBSS	39.594276	-77.053863	Meadow Branch UT2
DOUB-115-R-2002	DNR	MBSS	39.549762	-77.212062	Beaver Dam Creek
DOUB-116-R-2002	DNR	MBSS	39.678559	-76.943864	Big Pipe Creek UT7
DOUB-119-R-2002	DNR	MBSS	39.675751	-77.031028	Big Pipe Creek UT6
DOUB-120-R-2002	DNR	MBSS	39.613945	-77.055096	Bear Branch UT1
DOUB-122-R-2002	DNR	MBSS	39.648328	-76.996590	Bear Branch
DOUB-212-R-2002	DNR	MBSS	39.555788	-77.068340	Turkeyfoot Run
DOUB-214-R-2002	DNR	MBSS	39.661544	-76.951741	Big Pipe Creek
DOUB-217-R-2002	DNR	MBSS	39.604572	-77.107051	Meadow Branch
DOUB-218-R-2002	DNR	MBSS	39.687225	-77.056551	Big Silver Run
DOUB-221-R-2002	DNR	MBSS	39.636296	-77.058545	Bear Branch
DOUB-404-R-2002	DNR	MBSS	39.583064	-77.225819	Little Pipe Creek
DOUB-407-R-2002	DNR	MBSS	39.613993	-77.239016	Big Pipe Creek



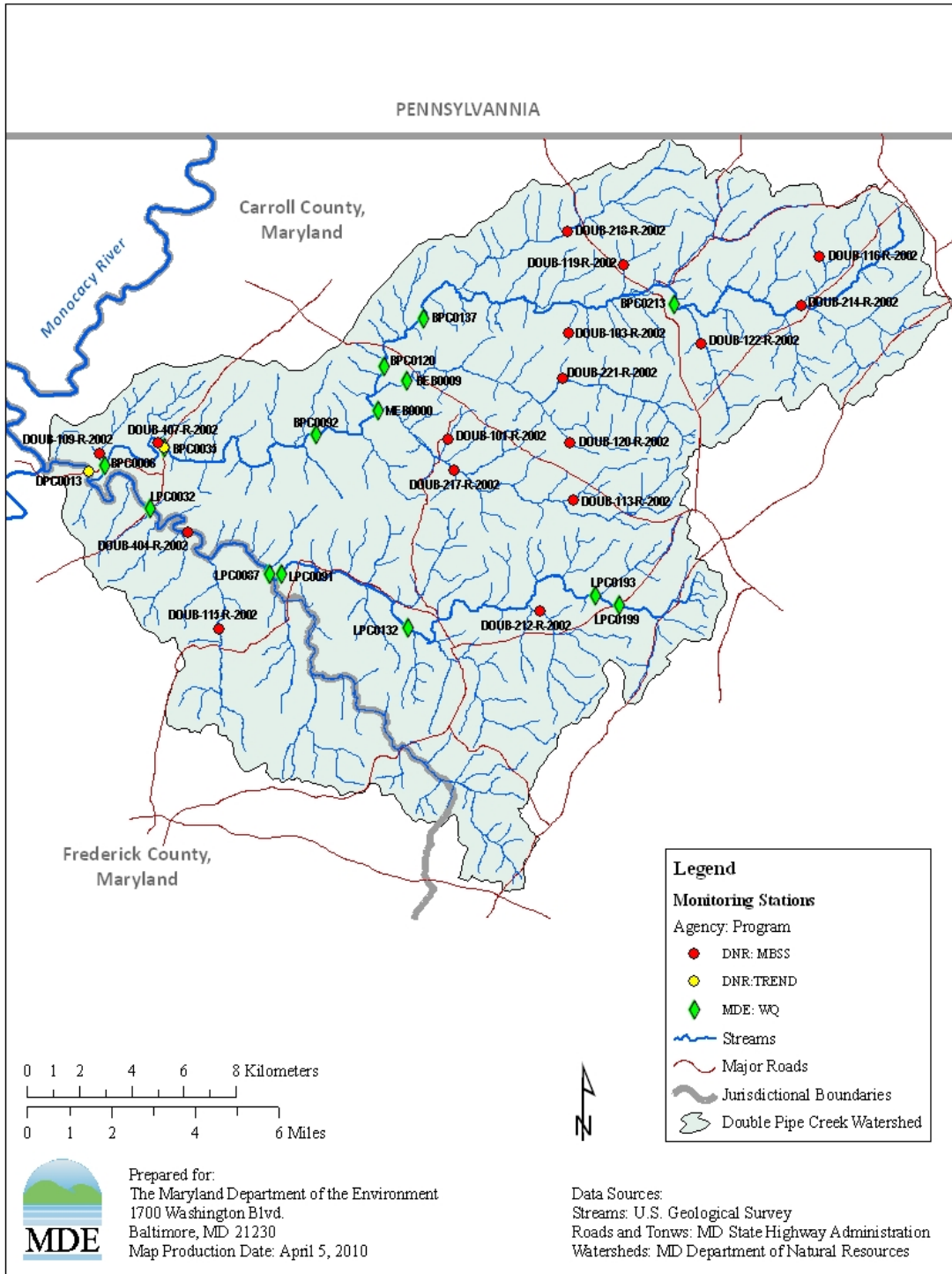

**Figure 3: Monitoring Stations in the Double Pipe Creek Watershed**

### **2.3.1 Biological Stressor Identification (BSID) Analysis**

MDE has developed a biological assessment methodology to support the determination of proper category placement for 8-digit watershed listings in the State's Integrated Report.

The BSID methodology uses data available from the statewide Maryland Department of Natural Resources Maryland Biological Stream Survey (DNR MBSS). The current MDE biological assessment methodology is a three-step process: (1) a data quality review, (2) a systematic vetting of the dataset, and (3) a watershed assessment that guides the assignment of biological stressors to Integrated Report categories.

The BSID analysis for the Double Pipe Creek watershed identified both phosphorus and nitrogen as a potential stressors. Both total phosphorus and orthophosphate show a significant association with degraded biological conditions. As much as 15% of the biologically impacted stream miles in the watershed are associated with high total phosphorus and 14% are associated with high orthophosphate. Similarly, according to the BSID analysis, 65% of the biologically impacted stream miles in the Double Pipe Creek watershed are associated with high total nitrogen concentrations. Based on the results of the analysis, the BSID report concludes that nitrogen and phosphorus are associated with impairments to aquatic life or biological communities in the Double Pipe Creek watershed.

The BSID analysis also examines whether low DO concentrations are associated with degraded biological conditions. The analysis for the Double Pipe Creek watershed concludes that 16% of the biologically impacted stream miles in the watershed are associated with DO concentrations below 5 mg/l, but none of the impact stream miles where Use III-P DO criteria apply, are associated with DO concentrations below 6 mg/l. The indirect impact of nutrients on nontidal aquatic systems is complex and the science continues to evolve. While DO was not found to be associated with poor biological conditions, there could be confounding effects such as increased primary production resulting in periphyton growth and also diurnal fluctuations. At this time, both the original 1998 listing and the initial BSID analysis point to nutrients in general and phosphorus in particular, as a biological stressor in Double Pipe Creek.

For details on the BSID analysis, please refer to the documents "*Watershed Report for Biological Impairment of the Double Pipe Creek Basin in Frederick and Carroll Counties, Maryland - Biological Stressor Identification Analysis Results and Interpretation*" (MDE 2011) and "*Maryland Biological Stressor Identification Process*" (MDE 2009a).

### **2.3.2 Dissolved Oxygen**

DNR collected DO samples in the Double Pipe Creek watershed for its CORE/TREND program from January 1998 through June 2007 and for its MBSS program in 2002. MDE collected DO samples from October 2001 through December 2005. Samples taken during the growing season (May through October) show DO concentrations ranging from 3.5 to 11.1 mg/l, with only three out of 237 samples below the DO criterion of 5 mg/l. Where Use III-P DO criteria apply, no stations had DO concentrations of less than 6 mg/l during

the growing season. The monitoring data indicate that under current conditions, the water quality standard for DO is being met in Double Pipe Creek. These data are presented graphically in Figure 4.

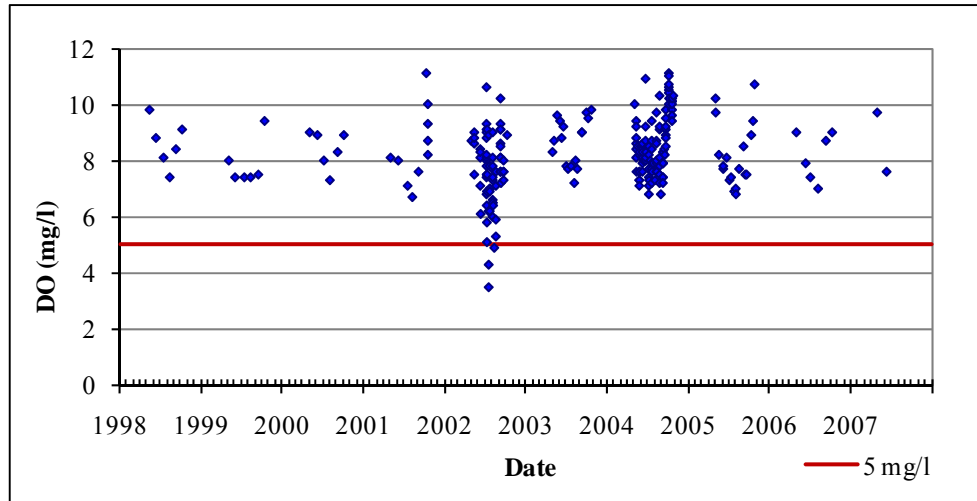
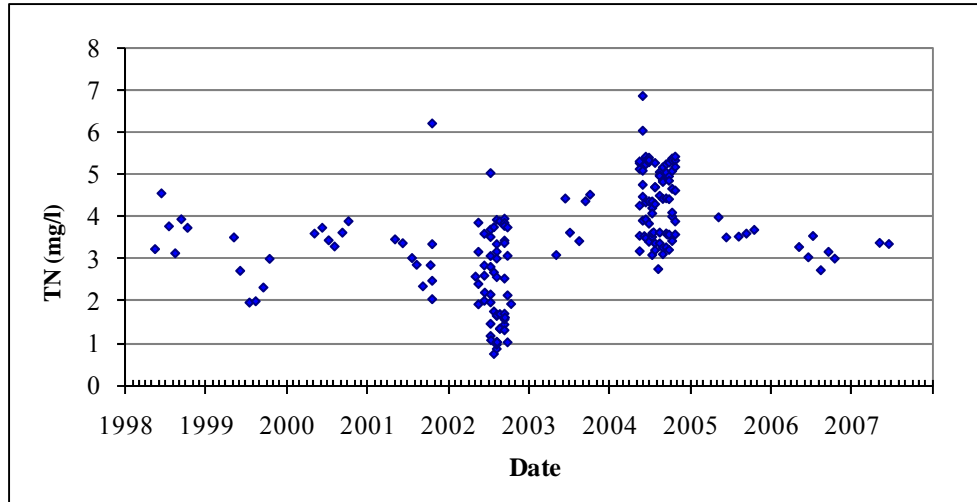

**Figure 4: Double Pipe Creek Dissolved Oxygen Data from 1998 through 2007**

### 2.3.3 Nutrients

In the absence of State water quality standards with specific numeric limits for nutrients for the protection of aquatic life in non-tidal free-flowing waters, evaluation of potentially eutrophic conditions is based on the BSID analysis and analysis of dissolved oxygen levels. Consequently, the nutrients data presented in this section are for informational purposes only.

Total nitrogen (TN) and total phosphorus (TP) data for the Double Pipe Creek watershed have been collected as part of this study, and the results are presented here for informational purposes. During the growing season, DNR and MDE measured total nitrogen (TN) concentrations ranging from 0.76 to 6.87 mg/l and total phosphorus (TP) concentrations ranging from 0.01 to 1.23 mg/l. These data are presented graphically in Figures 5 and 6.



**Figure 5: Double Pipe Creek Total Nitrogen Data from 1998 through 2007**

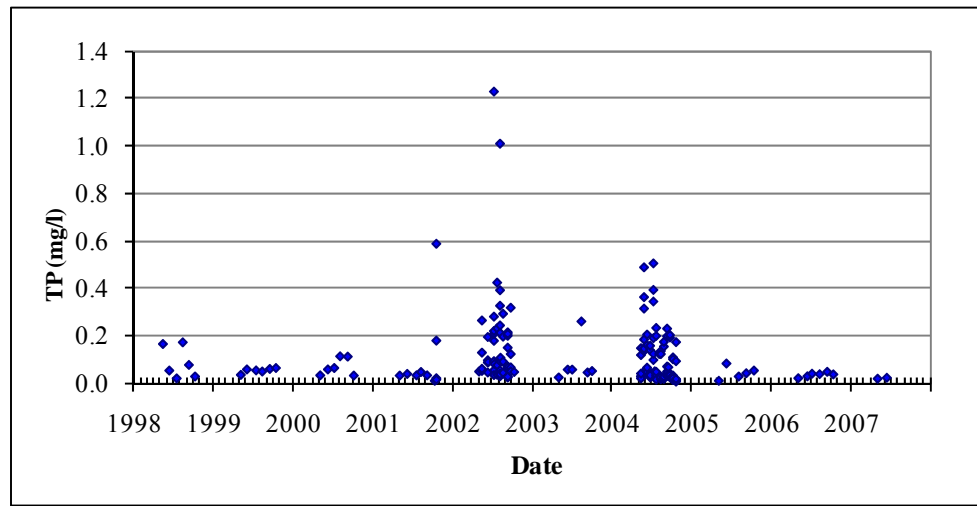

**Figure 6: Double Pipe Creek Total Phosphorus Data from 1998 through 2007**

### 2.3.4 Nutrient Limitation

Nitrogen and phosphorus are essential nutrients for algae growth. If one nutrient is available in great abundance relative to the other, then the nutrient that is less available limits the amount of plant matter that can be produced; this is known as the “limiting nutrient.” The amount of the abundant nutrient does not matter because both nutrients are needed for algae growth. In general, a total nitrogen:total phosphorus (TN:TP) ratio in the range of 5:1 to 10:1 by mass is associated with plant growth being limited by neither phosphorus nor nitrogen. If the TN:TP ratio is greater than 10:1, phosphorus tends to be limiting; if the TN:TP ratio is less than 5:1, nitrogen tends to be limiting (Chiandani *et al.* 1974).

Almost 95% of the samples collected in the Double Pipe Creek watershed 1998-2007 have TN:TP ratios of greater than 10, and less than one percent of the samples have TN:TP ratios greater than 5. The average TN:TP ratio is 102 and the median is 77. All but three of the samples with ratios below ten were taken in the summer of 2002, when flows were near record lows. Extremely low-flow conditions can promote denitrification and reduce the TN:TP ratio (Borchardt 1996). Only one of the sixteen MBSS samples has a TN:TP ratios below ten. Their median ratio is 136 and the average ratio is 154.

The observed data strongly imply that streams in the Double Pipe Creek watershed are phosphorus limited.

### 2.3.5 Double Pipe Creek Mainstem Benthic Macroinvertebrate Monitoring Stations

Additional biological data for Double Pipe Creek were obtained from the Maryland Department of Natural Resources (DNR) CORE/TREND Program (DNR 2007a, 2009). The program collected benthic macroinvertebrate data between 1976 and 2006. The DNR CORE/TREND program has monitoring information for two stations in the Double Pipe Creek watershed. The stations are BPC0035 located on Big Pipe Creek, the larger of the two main tributaries to Double Pipe Creek, and DPC0013 located just below the confluence of Big Pipe and Little Pipe Creeks. The Big Pipe Creek station has 21 years of data between 1977 and 2006. The Double Pipe Creek station has 15 years of data between 1977 and 2006. These data were used to calculate four benthic community measures: total number of taxa, Shannon-Wiener diversity index, modified Hilsenhoff biotic index, and percent *Ephemeroptera*, *Plecoptera*, and *Trichoptera* (EPT). A summary of the results for each of the stations is presented in Table 7.

**Table 7: Double Pipe Creek Mainstem DNR TREND Data**

Site Number	Current Water Quality Status	Trend Since 1970's
BPC0035	Good/Very Good	Degradation
DPC0013	Good	Degradation

## 2.4 Water Quality Impairment

The Maryland Surface Water Use Designation in the Code of Maryland Regulations (COMAR) for the Double Pipe Creek mainstem and its tributaries is Use I-P/Use III-P/Use IV-P (*Water Contact Recreation, Protection of Nontidal Warm Water Aquatic Life and Public Water Supply; Water Contact Recreation, Protection of Nontidal Cold Water Aquatic Life and Public Water Supply; Water Contact Recreation, Protection of Aquatic Life and Recreational Trout Waters and Public Water Supply*) (COMAR 2012a,b,c,d). The water quality impairment of the Double Pipe Creek watershed addressed by this TMDL is caused by elevated nutrient loads beyond a level that is supportive of aquatic

health, where aquatic health is evaluated based on BIBI and FIBI scores (BIBI and FIBI  $\geq$  3). The BSID has identified total phosphorus as associated with 15% of the biologically impaired stream miles in the Double Pipe Creek watershed, orthophosphate as associated with 14% of biologically impaired stream miles, and nitrogen as associated with 65% of the biologically impaired stream miles.

The BSID analysis indicates that 16% of the biologically impacted stream miles are associated with DO concentrations less than 5 mg/l. The analysis of DO monitoring data in section 2.3.1, however, indicates that overall, DO criteria are currently met in the watershed.

Biological results from the DNR CORE/TREND stations on Big Pipe Creek mainstem (BPC0035) and the Double Pipe Creek mainstem (DPC0013) indicate that, based on percent EPT, taxa number, biotic index, and diversity index, water quality can be classified as Good (Table 8). No CORE/TREND stations are located in the Little Pipe Creek subwatershed. BIBI and FIBI values from the DNR MBSS samples indicate that the 1<sup>st</sup> through 4<sup>th</sup> order tributaries in the Double Pipe Creek watershed are biologically impaired. Because the benthic macroinvertebrate monitoring results from the DNR CORE/TREND stations BPC0035 and DPC0013 indicate the Big Pipe Creek and the Double Pipe Creek mainstems are supporting their aquatic life use, MDE concludes that only the lower order streams in the Double Pipe Creek watershed are nutrient impaired, including Little Pipe Creek and its tributaries.

The BSID analysis also associated high concentrations of total nitrogen with the biological impairment in the Double Pipe Creek watershed. The 1996 nutrients listing was refined in Maryland's 2008 Integrated Report to a listing for phosphorus as the specific impairing nutrient substance. The revised listing was based on the generally accepted view within the scientific community that in fresh water, phosphorus is usually the limiting nutrient for algal growth (Allan 1995, Correll 1998). The analysis of observed TN:TP ratios in Section 2.3.4 confirms the assumption that phosphorus is the limiting nutrient in smaller order streams in the Double Pipe Creek watershed. Because nitrogen generally exists in quantities greater than necessary to sustain algal growth, excess nitrogen *per se* is not the cause of the biological impairment in Double Pipe Creek, and the reduction of nitrogen loads would not be an effective means of ensuring that the Double Pipe Creek watershed is free from impacts on aquatic life due to eutrophication. Therefore, load allocations for the Double Pipe Creek Nutrient TMDL will apply only to total phosphorus. Reductions in nitrogen loads will be required in the Double Pipe Creek watershed to meet the nitrogen allocations assigned to the Potomac Tidal Fresh Bay Water Quality Segment by the Chesapeake Bay TMDL, established by the EPA on December 29, 2010.

### 3.0 TARGETED WATER QUALITY GOAL

The objective of the phosphorus TMDL established herein is to reduce phosphorus loads, and subsequent effects on aquatic health, in the Double Pipe Creek watershed to levels that support the Use I-P (*Water Contact Recreation, Protection of Nontidal Warm Water Aquatic Life, and Public Water Supply*), III-P (*Water Contact Recreation, Protection of Nontidal Cold Water Aquatic Life, and Public Water Supply*) or Use IV-P (*Water Contact Recreation, Protection of Aquatic Life, Recreational Trout Waters and Public Water Supply*) designations (COMAR 2012a,b,c,d). Assessment of aquatic health is based on Maryland's biocriteria protocol, which evaluates both the amount and diversity of the benthic and fish community through the use of the Index of Biotic Integrity (IBI) (Roth *et al.* 1998, 2000, Stribling *et al.* 1998). Reduction in phosphorus loads are expected to result in improved benthic and fish communities, by either improving habitat conditions or restoring energy pathways to patterns to those typical of healthy biological communities in the Piedmont and Highland ecoregions.

As noted before, there are no numeric criteria in Maryland that quantify the impact of nutrients on the aquatic health of non-tidal stream systems; therefore, a reference watershed TMDL approach was used. Phosphorus loads compatible with water quality standards are determined by comparing current phosphorus loading rates (lbs/ac/yr) in the Double Pipe Creek watershed with the nutrient loading rates in unimpaired watersheds in the Piedmont and Highland ecoregions of Maryland. The Chesapeake Bay Program's (CBP) Phase 5.3.2 Watershed Model (P5.3.2) will be used to determine the phosphorus loads in both Double Pipe Creek and the unimpaired watersheds that will be used to set the phosphorus TMDL for Double Pipe Creek.

Overall, this TMDL will establish phosphorus loads that will be protective of the Use I-P/Use III-P/Use IV-P designations for the Double Pipe Creek watershed, and more specifically, these loads will be at a level the watershed can sustain without causing nutrient related impacts to aquatic health. The TMDL, however, will not completely resolve the impairment to biological communities within the watershed. Because the BSID watershed analysis identifies other possible stressors (*i.e.*, conductivity, inadequate riparian habitat, and sediment related stressor) as impacting the biological conditions, this impairment remains to be fully addressed through the Integrated Report listing process and the TMDL development process, such that all impairing substances identified as impacting biological communities in the watershed are reduced to levels that will meet water quality standards, as established in future TMDLs for those substances (MDE 2009a).

## **4.0 TOTAL MAXIMUM DAILY LOADS AND SOURCE ALLOCATION**

### **4.1 Overview**

This section describes how the phosphorus TMDL and load allocations (LA) were developed for Double Pipe Creek. Section 4.2 describes the analysis framework for estimating phosphorus loading rates and the assimilative capacity of the watershed stream system. Section 4.3 summarizes the scenarios that were used in the analysis and presents results. Section 4.4 discusses critical conditions and seasonality. Section 4.5 explains the calculations of TMDL loading caps. Section 4.6 details the load allocations, and Section 4.7 explains the rationale for the margin of safety. Finally, Section 4.8 summarizes the TMDL.

### **4.2 Analysis Framework**

Because there are no specific numeric criteria that quantify the impact of nutrients on the aquatic health of nontidal stream systems, a reference watershed approach will be used to establish the TMDL. Furthermore, as the BSID analysis established a link between biological impairment and nutrient related stressors, the reference watershed approach will utilize a biological endpoint.

#### **Watershed Model**

An essential element in the reference watershed approach is the use of a computer simulation model to determine the current or baseline loads in the impaired and reference watersheds. These loads are used to calculate the loading rate in the reference watershed and therefore the TMDL load allocations for the impaired watershed. For the Double Pipe Creek phosphorus TMDL, and other nutrient TMDLs for Maryland's non-tidal watersheds, the CBP Phase 5.3.2 Watershed Model will be used to determine phosphorus loads in both the impaired and reference watersheds.

The CBP P5.3.2 model is a Hydrological Simulation Program FORTRAN (HSPF) model of the portions of Maryland, Virginia, Pennsylvania, Delaware, New York, and West Virginia, and the District of Columbia in the Chesapeake Bay basin. Its primary purposes are (1) to determine the sources of nitrogen, phosphorus, and sediment to the Chesapeake Bay, (2) to calculate nutrient and sediment loads to the Chesapeake Bay for use in the CBP water quality and sediment transport model, and (3) to estimate nutrient and sediment load allocations under nutrient and sediment TMDLs for impaired Chesapeake Bay segments. Generally, river reaches that have average annual flows greater than 100 cubic feet per second (cfs) are represented in the model, but MDE has worked with CBP to ensure that all of MD's 8-digit watersheds, the unit of water quality assessment in MD, are represented in the model.

Bicknell *et al.* (2001) describe the HSPF model in greater detail. (US EPA 2010b) documents the development of the Phase 5 Watershed Model.



An important aspect of the P5.3.2 model is that it imposes a uniform and consistent methodology for calculating nutrient input loads to land segments. The P5.3.2 model also uses automated calibration procedures to determine land and river parameters as well as the regional factors for EOS loads discussed in Section 2.2.1. This ensures that the land and river segments are simulated in a consistent manner and therefore the allocation of loads under Bay TMDLs is equitable. This aspect of the P5.3.2 model is important for the reference watershed approach, because the uniform and consistent approach to estimation of nutrient loads across watersheds gives greater validity to using load estimates from one watershed to set the TMDL endpoint for another. The P5.3.2 model is used to assign load and wasteload allocations for the Chesapeake Bay TMDLs. The load estimates from the P5.3.2 model will therefore shape water quality management in Maryland for the near future. The results of the model will affect point source and MS4 permits, as well as nonpoint source management programs for agriculture, silviculture, and stream restoration. Using the P5.3.2 model as the basis for the reference watershed approach enables Maryland to integrate its non-tidal nutrient TMDLs into the nutrient management framework for the Chesapeake Bay. It also provides a consistent and equitable way to determine the load contribution from neighboring states.

### **Reference Watershed Approach**

In order to quantify the impact of phosphorus on the aquatic health of non-tidal stream systems, a reference watershed TMDL approach was used, that resulted in the establishment of a *phosphorus loading threshold* for watersheds within the Highland and Piedmont physiographic regions. The phosphorus loading threshold was determined by a methodology similar to that used to develop sediment loading thresholds for Maryland's sediment TMDLs (Currey *et al.* 2006, MDE 2009b). Reference watersheds were determined based on Maryland's biocriteria methodology. The biocriteria methodology assesses biological impairment at the 8-digit watershed scale based on the percentage of MBSS monitoring stations, translated into watershed stream miles, which are degraded. Individual monitoring station impairment is determined based on BIBI/FIBI scores lower than the Minimum Allowable IBI Limit (MAL), which is calculated based on the average annual allowable IBI value of 3.0 (on a scale of 1 to 5). Applying the MAL threshold helps avoid classification errors when assessing biological impairment (Roth *et al.* 1998, 2000, Stribling *et al.* 1998, MDE 2010).

Comparison of watershed phosphorus loads to loads from reference watersheds requires that the watersheds be similar in physical and hydrological characteristics. To satisfy this requirement, Currey *et al.* (2006) selected reference watersheds only from the Highland and Piedmont physiographic regions (see Appendix A for the list of reference watersheds). This region is consistent with the non-coastal region that was identified in the 1998 development of FIBI and subsequently used in the development of BIBI (Roth *et al.* 1998, Stribling *et al.* 1998).

To reduce the effect of the variability within the Highland and Piedmont physiographic regions, the watershed phosphorus loads were then normalized by a constant background condition: the all forested watershed condition. This new normalized term, defined as the

*forest normalized phosphorus load* ( $Y_n$ ), represents how many times greater the current watershed phosphorus load is than the *all forested phosphorus load*. The same methodology has been used to develop sediment TMDLs for non-tidal streams in Maryland (Currey *et al.* 2006, MDE 2009b). The *forest normalized phosphorus load* for this TMDL is calculated as the current watershed phosphorus load (calculated using the CBP P5.3.2 2009 Progress Scenario) divided by the *all forested phosphorus load*.

The equation for the *forest normalized phosphorus load* is as follows:

$$Y_n = \frac{y_{ws}}{y_{for}} \quad (\text{Equation 4.1})$$

where:

- $Y_n$  = forest normalized phosphorus load
- $y_{ws}$  = current watershed phosphorus load (lbs/yr)
- $y_{for}$  = all forested phosphorus load (lbs/yr)

Based on Equation 4.1, the *forest normalized phosphorus load* for the Double Pipe Creek watershed is 11.30.

Twelve reference watersheds were selected from the Highland/Piedmont region. Reference watershed *forest normalized phosphorus loads* were calculated using CBP P5.3.2 2009 Progress Scenario landuse and phosphorus loads. Table A-1 in Appendix A shows the annual forest normalized phosphorus loads for reference watersheds, averaged over the simulation period 1991-2000 from the CBP P5.3.2 2009 Scenario. The median and 75<sup>th</sup> percentile of the reference watershed *forest phosphorus loads* were calculated and found to be 7.18 and 8.71 respectively. The median value of 7.18 was established as the *phosphorus loading threshold* as an environmentally conservative approach to develop this TMDL.

Double Pipe Creek's forest normalized load exceeds the *forest normalized reference phosphorus load* (also referred to as the *phosphorus loading threshold*), indicating that the Double Pipe Creek watershed is receiving loads above the maximum allowable load the watershed can sustain without causing any phosphorus related impacts to aquatic health.

### 4.3 Scenario Descriptions and Results

The following analyses allow a comparison of baseline conditions (under which water quality problems exist) with future conditions, which project the water quality response to various simulated phosphorus load reductions. The analyses are grouped according to baseline conditions and future conditions associated with the TMDL.

#### **Baseline Conditions**

The baseline conditions are intended to provide a point of reference by which to compare the future scenario that simulates conditions of a TMDL. The baseline conditions typically

reflect an approximation of nonpoint source loads during the monitoring time frame, as well as estimated point source loads based on discharge data for the same period.

The Double Pipe Creek watershed baseline nutrient loads are estimated using the landuse and EOS phosphorus loading rates from the CBP P5.3.2 2009 Progress Scenario. The 2009 Progress Scenario represents current land-use, loading rates, and BMP implementation simulated using precipitation and other meteorological inputs from the period 1991-2000 to represent variable hydrological conditions, thereby addressing annual changes in hydrology and capturing wet, average and dry years. The period 1991-2000 is the baseline hydrological period for the Chesapeake Bay TMDL.

Watershed loading calculations, based on the CBP P5.3.2 segmentation scheme, are represented by multiple CBP P5.3.2 model segments within each MD 8-digit watershed. The phosphorus loads from these segments are combined to represent the baseline condition. The Maryland point source nutrient loads are estimated based on discharge monitoring data and existing permit information. Details of these loading source estimates can be found in Section 2.2 and Section 4.6 of this report. The total baseline phosphorus load for the Double Pipe Creek watershed is 201,916 lbs per year.

### **Future (TMDL) Conditions**

This scenario represents the future conditions associated with the maximum allowable phosphorus loads whereby there will be no phosphorus related impacts affecting aquatic health. In the TMDL calculation, the allowable load for the impaired watershed is calculated as the product of the *phosphorus loading threshold* (determined from watersheds with healthy biological communities) and the Double Pipe Creek *all forested phosphorus load* (see Section 4.2). The resulting load is considered the maximum allowable load the watershed can sustain without causing any nutrient related impacts to aquatic health.

The TMDL loading and associated reductions are averaged at the MD 8-digit watershed scale, which is consistent with the impairment listing scale. It is important to recognize that some subwatersheds may require higher reductions than others, depending on the distribution of the land-use.

The formula for estimating the TMDL is as follows:

$$TMDL = Y_{ref} \cdot y_{forest} \quad (\text{Equation 4.2})$$

where:

TMDL = allowable load for impaired watershed (lbs/yr)

$Y_{ref}$  = phosphorus loading threshold

*i.e.*, forest normalized reference phosphorus load (7.18)

$y_{forest}$  = all forested phosphorus load for watershed (lbs /yr)

The future (TMDL) load for Double Pipe Creek watershed is 128,328 lbs per year phosphorus, which represents an overall 36% reduction from baseline loads.

#### **4.4 Critical Conditions and Seasonality**

EPA's regulations require TMDLs to take into account seasonality and critical conditions for stream flow, loading, and water quality parameters (CFR 2011b). The intent of this requirement is to ensure that the water quality of the waterbody is protected during times when it is most vulnerable.

The premise of the reference watershed approach is that the reference watershed is meeting water quality standards even under critical conditions. Therefore, the phosphorus loading rates derived from the reference watershed protects water quality standards under critical conditions. Moreover, the loading rates used in the TMDL were determined using the HSPF model, which is a continuous simulation model with a simulation period 1991-2000. The ten year simulation period encompasses seasonal variations and a range of hydrological and meteorological conditions.

The biological monitoring data used to determine the reference watersheds also integrates the stress effects over the course of time and thus inherently addresses critical conditions. Seasonality is captured in two respects. First, it is implicitly included through the use of the biological monitoring data. Second, the MBSS dataset included benthic sampling collected in the spring and fish sampling collected in the summer. Thus, this analysis has captured both spring and summer flow conditions.

#### **4.5 TMDL Loading Caps**

This section presents the average annual TMDL of phosphorus for the Double Pipe Creek watershed. These loads are considered the maximum allowable long-term average annual load the watershed can sustain without causing nutrient related impacts to aquatic health.

The long-term average annual TMDL was calculated based on Equation 4.2. In order to attain the TMDL loading cap calculated for the watershed, reductions to phosphorus baseline loads will be applied to the controllable sources. Significant phosphorus reductions will be required in the Double Pipe Creek watershed to meet the phosphorus allocations assigned to the Potomac Tidal Fresh Bay Water Quality Segment by the Chesapeake Bay TMDL, established by the EPA on December 29, 2010. To ensure consistency with the Bay TMDL, and therefore efficiency in the reduction of phosphorus loads, reductions will be applied to the same controllable sources identified in Maryland's Watershed Implementation Plans (WIPs) for the Bay TMDL. The controllable sources include: (1) regulated developed land; (2) high till crops, low till crops, hay, and pasture; (3) harvested forest; (4) unregulated animal feeding operations and CAFOS; and (5) industrial process water sources and municipal wastewater treatment plants. Additional sources might need to be controlled in order to ensure that the water quality standards are attained in the Chesapeake Bay as well as in the Double Pipe Creek.

An overall reduction of 36% for phosphorus from current estimated loads will be required to meet TMDL allocations and attain Maryland water quality standards. The baseline and TMDL scenarios for Double Pipe Creek watershed are presented in Table 8.

**Table 8: Double Pipe Creek Watershed TMDL for Phosphorus**

Baseline Load (lbs/yr)	TMDL (lbs/yr)	Total Reduction (%)
201,916	128,328	36%

#### 4.6 Load Allocations Between Point and Nonpoint Sources

Per EPA regulation, all TMDLs need to be presented as a sum of waste load allocations (WLAs) for permitted point sources in the assessment unit and load allocations (LAs) for nonpoint sources generated within the assessment unit. In addition, TMDLs must account for natural background, tributary and adjacent segment loads, if applicable (CFR 2011b). Consequently, the Double Pipe Creek watershed TMDL allocations are presented in terms of WLAs (*i.e.*, point source loads identified within the watershed) and LAs (*i.e.*, the nonpoint source loads within the watershed). The State reserves the right to allocate the TMDL among different sources in any manner that is reasonably calculated to protect aquatic life from nutrient related impacts.

Table 9 summarizes the TMDL scenario results for phosphorus. Equal reductions were applied to phosphorus loads from controllable sources. Controllable loads were determined, in accordance with the Chesapeake Bay TMDL (US EPA 2010), as the difference between the CBP 2010 “No Action” Scenario and the “E3” Scenario, where the No Action Scenario represents current land uses and point sources without nutrients controls, while the E3 Scenario represents application of all possible BMPs and control technologies to current land uses and point sources. This allocation methodology provides credit for existing BMPs in place, which is one the reasons the resulting reduction vary among source sectors.

In this watershed; crop, pasture, nurseries, developed land, and municipal WWTPs were identified as the largest controllable sources. Forest is the primary non-controllable source, as it represents the most natural condition in the watershed. Direct atmospheric deposition on water is a minor source that to a large extent originates outside the watershed. Atmospheric deposition will be reduced by existing state and federal programs and thus is not addressed in this TMDL. Urban stormwater nutrient loads are regulated under the NPDES MS4 program and therefore included in the WLA. There are no CSOs in the Double Pipe Creek watershed, and phosphorus loads from septic systems are considered insignificant.

The Double Pipe Creek Phosphorus TMDL requires a 32% reduction in phosphorus loads from nonpoint sources (See Table 9 below). For more detailed information regarding the

FINAL

Double Pipe Creek Watershed TMDL Contribution nonpoint source allocations, please see the technical memorandum to this document entitled “*Significant Phosphorus Nonpoint Sources in the Double Pipe Creek Watershed*”.

The waste load allocation (WLA) of the Double Pipe Creek watershed is allocated in three categories: Process Water WLA, Stormwater WLA, and CAFO WLA. The categories are described below.

### **Process Water WLA**

There are six municipal WWTPs in the Double Pipe Creek watershed. Municipal WWTPs are assigned phosphorus WLAs as follows: (1) if the design flow of a facility is greater than 0.5 MGD and therefore is slated for upgrade to ‘Enhanced Nutrient Reduction’ (ENR), then the facility is given a WLA based on its design flow and the anticipated average annual ENR concentrations of 0.3 mg/l TP; (2) if the design flow of the facility is 0.5 MGD or less and has TP concentration limits, then that facility is assigned a WLA based on its Maryland Tributary Strategy Cap flow and the permit limit; and (3) if the facility does not have permit limits, it is assigned a WLA based on its Maryland Tributary Strategy Cap flow and an assumed maximum average annual concentration of 3 mg/l TP. The Tributary Strategy Cap flow is the design flow of the facility or the projected 2020 flow (projected from 2003 actual discharge flows and Maryland Department of Natural Resources growth rates by county), whichever is less.

Six industrial facilities discharging process water in the Double Pipe Creek watershed were judged to have the capacity to discharge TP in their process water. All of these facilities are minor. Under the Chesapeake Bay TMDL, industrial facilities capable of discharging phosphorus in their process water were given a WLA based on the results of monitoring required by their permits or professional judgment. In addition, allocations for minor municipal WWTPs (with design flows less than 0.5 MGD) and for minor industrial facilities are presented in the Chesapeake Bay TMDL as a watershed-wide aggregate WLA. A similar approach was adopted for the Double Pipe Creek Phosphorus TMDL, and all minor municipal and minor industrial process water facilities allocations are represented as a watershed-wide WLA.

Overall, based on the Maryland Tributary Strategy Cap flow and permit limits or the allocation under the Chesapeake Bay TMDL, applied to the Double Pipe Creek Phosphorus TMDL, it will result in a 42% reduction in phosphorus loads from process water sources (See Table 9). This reduction is a result of statewide policy decisions related to process water. For additional information regarding the individual allocation to the major process water facility as well as information related to minor process water facilities included in the minor aggregate WLA, please see the technical memorandum to this document entitled “*Significant Phosphorus Point Sources in the Double Pipe Creek Watershed*”.

### **Stormwater WLA**

Per EPA requirements, “stormwater discharges that are regulated under Phase I or Phase II of the National Pollutant Discharge Elimination System (NPDES) stormwater program are point sources that must be included in the WLA portion of a TMDL” (US EPA 2002). The NPDES stormwater program covers the following types of discharges:

- MS4s – these can be owned by local jurisdictions, municipalities, and state and federal entities (*i.e.*, departments of transportation, hospitals, military bases, etc.);
- general industrial stormwater permitted facilities; and
- construction sites that are one acre or larger.

EPA recognizes that available data and information are usually not detailed enough to determine WLAs for NPDES regulated stormwater discharges on an outfall-specific basis (US EPA 2002). Therefore, NPDES regulated stormwater loads within the Double Pipe Creek watershed TMDL will be expressed as a single NPDES stormwater WLA. Upon approval of the TMDL, “NPDES-regulated municipal stormwater and small construction storm water discharges effluent limits should be expressed as BMPs or other similar requirements, rather than as numeric effluent limits” (US EPA 2002).

The Double Pipe Creek NPDES stormwater WLA is based on reductions applied to the controllable phosphorus loads from the regulated developed landuse in the watershed, with credit provided to existing BMPs in place. The Double Pipe Creek NPDES stormwater WLA requires an overall reduction of 64% for phosphorus (See Table 9).

As stormwater assessment and/or other program monitoring efforts result in a more refined source assessment, MDE reserves the right to revise the current NPDES stormwater WLA provided the revisions are reasonably calculated to protect aquatic life from nutrient related impacts.

For more information regarding the distribution of NPDES stormwater WLAs among jurisdictions, please see the technical memorandum to this document entitled “*Significant Phosphorus Point Sources in the Double Pipe Creek Watershed*”.

### **CAFO WLA**

Under the Clean Water Act, concentrated animal feeding operations (CAFOs) require NPDES permits for their discharges or potential discharges (CFR 2010c). In January, 2009, Maryland implemented new regulations governing CAFOs (COMAR 26.08.01, 26.08.03, and 26.08.04), which were approved by the EPA in January, 2010. Under these regulations, CAFOs are required to fulfill the conditions of a general permit. These conditions include instituting a Comprehensive Nutrient Management Plan (CNMP) which meets the Nine Minimum Standards to Protect Water Quality. The general permit also prohibits the discharge of pollutants, including nutrients, from CAFO production areas except as a result of event greater than the 25-year, 24-hour storm. The Double Pipe Creek Phosphorus TMDL requires a 54% reduction in phosphorus loads from CAFOs.

**Table 9: MD 8-digit Double Pipe Creek TMDL Phosphorus TMDL by Source Category**

Baseline Load Source Categories		Baseline Load (lbs/yr)	TMDL Components	TMDL (lbs/yr)	Reduction (%)
Nonpoint Source	Forest	5,792	LA	5,628	3%
	AFOs	3,646		500	86%
	Pasture	16,862		8,943	47%
	Crop	104,445		68,078	35%
	Nursery	34,073		29,385	14%
	Septic	0		0	0%
	Atmospheric Deposition	24		24	0%
<b>Total Nonpoint Source</b>		<b>164,842</b>		<b>112,555</b>	<b>32%</b>
Point Source	CAFOs	1,001	WLA	461	54%
	Regulated Urban	25,133		9,001	64%
	Process Water	10,940		6,310	42%
	CSO	0		0	0%
<b>Total Point Source</b>		<b>37,074</b>		<b>15,772</b>	<b>57%</b>
<b>Total</b>		<b>201,916</b>		<b>128,328</b>	<b>36%</b>

Note: Individual baseline loads may not add to total load due to rounding.

#### 4.7 Margin of Safety

All TMDLs must include a margin of safety to account for any lack of knowledge and uncertainty concerning the relationship between loads and water quality (CFR 2011a). It is proposed that the estimated variability around the reference watershed group used in this analysis already accounts for such uncertainty. Analysis of the reference watershed group *forest normalized phosphorus loads* indicates that approximately 75% of the reference watersheds have a value less than 8.71. Also, 50% of the reference watersheds have a value less than 7.18. Based on this analysis the *forest normalized reference phosphorus load* (also referred to as the *phosphorus loading threshold*) was set at the median value of 7.18. This is considered an environmentally conservative estimate, because 50% of the reference watersheds have a load above this value (7.18), which when compared to the 75% value (8.71), results in an implicit MOS of approximately 18%.

#### 4.8 Summary of Total Maximum Daily Loads

The average annual phosphorus TMDL for the Maryland 8-digit Double Pipe Creek watershed is summarized in Table 10. The Maryland Maximum Daily Phosphorus TMDL is summarized in Table 11 (See Appendix C for more details).



**Table 10: Average Annual MD 8-digit Double Pipe Creek TMDL of Phosphorus (lbs/yr)**

TMDL (lbs/yr)	LA		WLA			MOS
	LA <sub>DPC</sub>	Septic <sub>DPC</sub>	CAFO WLA <sub>DPC</sub>	NPDES Stormwater WLA <sub>DPC</sub>	Process Water WLA <sub>DPC</sub>	
<b>128,328</b>	112,555	0	461	9,001	6,310	Implicit

Note: Individual component loads may not add to Average Annual TMDL load due to rounding.

**Table 11: MD 8-digit Double Pipe Creek Maximum Daily Load of Phosphorus (lbs/day)**

TMDL (lbs/day)	LA		WLA			MOS
	LA <sub>DPC</sub>	Septic	CAFO WLA <sub>DPC</sub>	NPDES Stormwater WLA <sub>DPC</sub>	Process Water WLA <sub>DPC</sub>	
<b>918</b>	797	0	3	64	54	Implicit

## 5.0 ASSURANCE OF IMPLEMENTATION

Section 303(d) of the Clean Water Act and current EPA regulations require reasonable assurance that the TMDL load and wasteload allocations can and will be implemented. This section provides the basis for reasonable assurance that the phosphorus TMDL in the Double Pipe Creek will be achieved and maintained.

The Double Pipe Creek phosphorus TMDL is expected to be implemented as part of a staged process recently developed by Maryland. This staged process is designed to achieve both the nutrient reductions needed within the Double Pipe Creek watershed and to meet target loads consistent with the Chesapeake Bay TMDL, established by EPA in 2010 (US EPA 2010a) and scheduled for full implementation by 2025. The Bay TMDL requires reductions of nitrogen, phosphorus and sediment loads throughout the Bay watershed to meet water quality standards that protect the designated uses in the Bay and its tidal tributaries. The nutrient reductions for the Bay TMDL are independent of those needed to implement any TMDLs developed to address nutrient-related impairments in Maryland's non-tidal waterbodies, although their reduction goals and strategies do overlap. For example, the implementation planning framework, developed by the Bay watershed jurisdictions in partnership with EPA, provides a staged approach to achieving Bay TMDL nutrient reduction goals that is also applicable to implementation of nutrient TMDLs in local non-tidal watersheds. In short, nutrient reductions required to meet the Chesapeake Bay TMDL will also support the restoration and protection of local water quality.

Maryland's Phase I Watershed Implementation Plan (WIP) for the Chesapeake Bay TMDL, finalized in December 2010, identifies nutrient reduction targets by source sector for the Potomac Tidal Fresh segment-shed, which includes Double Pipe Creek and a number of other Maryland 8-digit watersheds. EPA revised the nutrient and sediment load allocations for the Bay TMDL in August 2011, based on results of the updated Phase 5.3.2 Watershed Model. Maryland has been working with key local partners, including county and municipal staff, soil conservation managers, and a variety of stakeholder organizations and business interests, to help them develop local implementation plans at the county scale. These local plans are being incorporated into the basin-scale implementation plans in the Phase II WIP, which will be finalized in July 2012.

Maryland's Phase II WIP and the State's schedule of two-year milestones provide implementation strategies and a time line for achieving nutrient reductions across the State to meet Chesapeake Bay interim target loads by 2017, equivalent to 60% of the final target goals set for 2025 to fully implement the Chesapeake Bay TMDL in Maryland. A Phase III Plan will be developed in 2017 to address the additional reductions needed from 2018 through 2025 to meet the final targets. Prior to Phase III, the TMDL allocations may again be revised to reflect better data, a greater understanding of the natural systems, and to make use of enhanced analytical tools (such as updated watershed and water quality models). This iterative process provides an adaptive approach for achieving the Chesapeake Bay TMDL goals, as well as a framework and time line for the staged implementation of the Double Pipe Creek non-tidal waters nutrient TMDL.

The proposed approach for achieving the Double Pipe Creek reduction targets will be based on deployment of an appropriate selection of the comprehensive implementation strategies described in Maryland's [Phase I WIP](#) (MDE 2010b) and [Phase II WIP](#) (MDE 2012b), the centerpieces of the State's "reasonable assurance" of implementation for the Bay TMDL. The strategies encompass a host of best management practices, pollution controls and other actions for all source sectors that cumulatively will result in meeting the State's 2017 interim nutrient and sediment reduction targets, as verified by the Chesapeake Bay Water Quality Model.

Accounting, tracking and reporting are an important part of the overall WIP strategy, and progress will be closely monitored for the two-year milestones by tracking both implementation and water quality. The setting of 2017 interim targets and a schedule of two-year milestone commitments will allow for an iterative, adaptive management process with ongoing assessments of implementation progress, as well as periodic reevaluation of nutrient impacts on local water quality. This staged approach provides further assurance that the implementation of the Double Pipe Creek phosphorus TMDL will be achieved through increased accountability and verification of water quality improvements over time.

Once the Bay TMDL nutrient target loads for the Double Pipe Creek watershed have been met, MDE will revisit the status of nutrient impacts on aquatic life in Double Pipe Creek, based on any additional monitoring data available and any improvements in the scientific understanding of the impacts of nutrients on aquatic life in free-flowing streams. The results of this reassessment will determine whether additional phosphorus reductions are needed in the watershed, or whether the Double Pipe Creek phosphorus TMDL goals have in fact been met.

#### Maryland Legislative Actions and Funding Programs to Support TMDL Implementation

Maryland recently enacted significant new legislation that requires Phase I MS4 jurisdictions to establish, by July 1, 2013, an annual stormwater remediation fee and a local watershed protection and restoration fund to support implementation of local stormwater management plans. Maryland has made a commitment to include provisions in Phase I and II MS4 permits, due for issuance in 2012, to implement the State's WIP strategies to reduce nutrient and sediment loads from urban stormwater sources.

Maryland has also enacted significant new legislation to increase the Bay Restoration Fund to provide financing for wastewater treatment plant upgrades and on-site septic system improvements, as well as legislation to guide growth of central sewer and septic systems. These new laws will support local efforts to reduce nutrient loads in both non-tidal watersheds and in downstream tidal waters of the Chesapeake Bay.

In response to the WIP and the increased burden on local governments to achieve nutrient reduction goals, Maryland has continued to increase funding in the Chesapeake and Atlantic Coastal Bays Trust Fund. For Fiscal Year 2013, in addition to \$25 million (pending) for the Trust Fund, \$38 million in general obligation bonds were made available

## FINAL

to local communities for implementation of stormwater capital improvements. These funds will not only kick start restoration at the local level, but also create and retain green jobs in Maryland's economy. Funding was also increased to support implementation of natural filters on public lands (\$9 million), and funding for Soil Conservation Districts from 16 to 39 positions (\$2.2 million). In addition, funding for the cover crop program is at \$12 million – a record level.

MD's Water Quality Improvement Act of 1998 (WQIA) requires that comprehensive and enforceable nutrient management plans be developed, approved and implemented for all agricultural lands throughout MD. This act specifically required such plans for nitrogen be developed and implemented by 2002, and plans for phosphorus be completed by 2005.

Additional potential funding sources for implementation include Maryland's Agricultural Cost Share Program (MACS) which provides grants to farmers to help protect natural resources, and the Environmental Quality and Incentives Program, which focuses on implementing conservation practices and BMPs on land involved with livestock and production.

For the 2012-2013 milestone period, Maryland is working to: restrict fall fertilization of small grain crops on soil testing above a given nitrate level thresholds; require incorporation of organic nutrient sources (with some exceptions); limit fall applications of organic nutrient sources; and require a cover crop following fall applications of organic nutrient sources. Future changes: nutrient application setbacks of 10-35 feet (depending upon application methods) will be required (2014); best management practices will be required for streams with adjacent livestock (2014); and winter application of all organic nutrient sources will be prohibited (2016-2020).

Maryland is also working to adopt a revised Phosphorus Site Index (PSI) and incorporate the new PSI into nutrient management plans in preparation for the 2013 crop season (winter 2012-2013).

To enhance Urban Nutrient Management as a nutrient reduction strategy, the State is working to develop regulations to implement the Fertilizer Use Act. This will: limit nitrogen and phosphorus content in fertilizer content and use on non-agricultural land; require certification and training for non-agricultural applicators; require certain fertilizer product labeling; and require outreach and education programs for homeowner fertilizer use.

For more information on Maryland's implementation and funding strategies to achieve nutrient and sediment reductions throughout the State's portion of the Chesapeake Bay watershed, please see Maryland's Phase II Watershed Implementation Plan.

## REFERENCES

- Allan, J. D. 1995. *Stream Ecology: Structure and Function of Running Waters*. Chapman and Hall, U. K. 400 pp.
- Baish, A. and M. J. Caliri. 2009. *Overall Average Stormwater Effluent Removal Efficiencies for TN, TP, and TSS in Maryland from 1984-2002*. Baltimore, MD: Johns Hopkins University.
- Baldwin, A. H., S. E. Weammert, and T. Simpson. 2007. *Pollutant Load Reductions from 1985-2002*. College Park, MD: Mid Atlantic Water Program.
- Bicknell, B.R., J.C. Imhoff, J.L. Kittle, Jr., and A.S. Donigian, Jr. 2000. Hydrological Simulation Program - FORTRAN (HSPF): User's Manual for Release 12.
- Beulac, M. N., and K. H. Reckhow. 1982. An Examination of Land Use – Nutrient Export Relationships. *Water Resources Bulletin*. 15. pp. 1013-1022.
- Borchardt, M. A. 1996. *Nutrients*. In: *Algal Ecology: Freshwater Benthic Ecosystems*. Stevenson, R.J., M. L. Bothwell, and R. L. Lowe (eds.). Academic Press, San Diego, CA.
- Chiandani, G. and M. Vighi. 1974. The N:P Ratio and Tests with *Selanastrum* to Predict Eutrophication in Lakes. *Water Research*, Vol. 8, pp. 1063-1069.
- Claggett, P., F. M. Irani, and R. L. Thompson. 2012. Estimating the Extent of Impervious Surfaces and Turf Grass across Large Regions. Submitted to American Water Resources Association (AWRA) Spring Specialty Conference: GIS and Water Resources VII. New Orleans, LA. March 26-27, 2012.
- Claytor, R., and T. R. Schueler. 1997. *Technical Support Document for the State of Maryland Stormwater Design Manual Project*. Baltimore, MD: Maryland Department of the Environment.
- CFR (Code of Federal Regulations). 2011a. *40 CFR 130.7*.  
[http://edocket.access.gpo.gov/cfr\\_2011/julqtr/40cfr130.7.htm](http://edocket.access.gpo.gov/cfr_2011/julqtr/40cfr130.7.htm) (Accessed March, 2012).
- \_\_\_\_\_. 2011b. *40 CFR 130.2(i)*.  
[http://edocket.access.gpo.gov/cfr\\_2011/julqtr/40cfr130.2.htm](http://edocket.access.gpo.gov/cfr_2011/julqtr/40cfr130.2.htm) (Accessed March, 2012).
- \_\_\_\_\_. 2011c. *40 CFR 122.23*.  
[http://edocket.access.gpo.gov/cfr\\_2011/julqtr/40cfr122.23.htm](http://edocket.access.gpo.gov/cfr_2011/julqtr/40cfr122.23.htm) (Accessed March, 2012).

COMAR (Code of Maryland Regulations). 2012a. 26.08.02.02.

<http://www.dsd.state.md.us/comar/getfile.aspx?file=26.08.02.02.htm> (Accessed March, 2012).

\_\_\_\_\_. 2012b. 26.08.02.08 P(1).

<http://www.dsd.state.md.us/comar/getfile.aspx?file=26.08.02.08.htm> (Accessed March, 2012).

\_\_\_\_\_. 2012c. 26.08.02.08 P(4)(l).

<http://www.dsd.state.md.us/comar/getfile.aspx?file=26.08.02.08.htm> (Accessed March, 2012).

\_\_\_\_\_. 2012d. 26.08.02.08 P(6)(a).

<http://www.dsd.state.md.us/comar/getfile.aspx?file=26.08.02.08.htm> (Accessed March, 2012).

\_\_\_\_\_. 2012e. 26.08.02.03-3 A(2), D(2).

<http://www.dsd.state.md.us/comar/getfile.aspx?file=26.08.02.08.htm> (Accessed March, 2012).

Correll, D. L. 1998. *The Role of Phosphorus in the Eutrophication of Receiving Waters: A Review*. J Environ Qual 27:261-266.

Currey, D. L., A. A. Kasko, R. Mandel, and M. J. Brush. 2006. *A Methodology for Addressing Sediment Impairments in Maryland's Non-tidal Watersheds*. Baltimore, MD: Maryland Department of the Environment. Also Available at [http://www.mde.state.md.us/assets/document/NT-Sediment\\_TMDL\\_Methodology\\_Report%281%29.pdf](http://www.mde.state.md.us/assets/document/NT-Sediment_TMDL_Methodology_Report%281%29.pdf)

DNR (Maryland Department of Natural Resources). 1996. *Maryland Water Quality Inventory, 1993-1995: A report on The Status of Natural Waters in Maryland Required by Section 305(b) of the Federal Water Pollution Control Act and Reported to the US Environmental Protection Agency and Citizens of the State of Maryland*. Annapolis, MD: Department of Natural Resources.

\_\_\_\_\_. 2007a. *Personal fax communication with Ellen Friedman*. Annapolis, MD: Department of Natural Resources, Monitoring and Non-Tidal Assessment Program.

\_\_\_\_\_. 2007b. *Physiography of Maryland*.

<http://www.dnr.state.md.us/forests/healthreport/mdmap.html> (Accessed March, 2012).

\_\_\_\_\_. 2009. *Benthic Macroinvertebrate Communities At Maryland's Core/Trend Monitoring Stations: Water Quality Status And Trends*. Annapolis, MD: Department of Natural Resources.

Edwards, J. 1981. *A Brief Description of the Geology of Maryland*. Maryland Geological Survey. <http://www.mgs.md.gov/esic/brochures/mdgeology.html> (Accessed March, 2012).

McCoy, J. L., and R. L. Summers. 1992. *Maryland Double Pipe Creek (RCWP8)*. <http://www.bae.ncsu.edu/programs/extension/wqg/info/rcwp/mdprof.html> (Accessed March, 2012).

MDE (Maryland Department of the Environment). 2004. *2004 List of Impaired Surface Waters [303(d) List] and Integrated Assessment of Water Quality in Maryland Submitted in Accordance with Sections 303(d) and 305(b) of the Clean Water Act*. Baltimore, MD: Maryland Department of the Environment. Also Available at [http://www.mde.state.md.us/programs/Water/TMDL/TMDLHome/Pages/Programs/WaterPrograms/tmdl/maryland%20303%20dlist/final\\_2004\\_303dlist.aspx](http://www.mde.state.md.us/programs/Water/TMDL/TMDLHome/Pages/Programs/WaterPrograms/tmdl/maryland%20303%20dlist/final_2004_303dlist.aspx).

\_\_\_\_\_. 2008. *2008 Integrated Report of Surface Water Quality in Maryland*. Also available at [http://www.mde.state.md.us/programs/Water/TMDL/Integrated303dReports/Pages/programs/waterprograms/tmdl/maryland%20303%20dlist/2008\\_final\\_303d\\_list.aspx](http://www.mde.state.md.us/programs/Water/TMDL/Integrated303dReports/Pages/programs/waterprograms/tmdl/maryland%20303%20dlist/2008_final_303d_list.aspx). (Accessed March, 2012).

\_\_\_\_\_. 2009a. *Maryland Biological Stressor Identification Process*. Baltimore, MD: Maryland Department of the Environment.

\_\_\_\_\_. 2009b. Addendum: Updates to *A Methodology for Addressing Sediment Impairments in Maryland's Non-tidal Watersheds*. Baltimore, MD: Maryland Department of the Environment.

\_\_\_\_\_. 2010a. *Final 2010 Integrated Report of Surface Water Quality in Maryland*. [http://www.mde.state.md.us/programs/Water/TMDL/Integrated303dReports/Pages/Final\\_approved\\_2010\\_ir.aspx](http://www.mde.state.md.us/programs/Water/TMDL/Integrated303dReports/Pages/Final_approved_2010_ir.aspx) (Accessed March, 2012).

\_\_\_\_\_. 2010b. *Maryland's Phase I Watershed Implementation Plan for the Chesapeake Bay Total Maximum Daily Load*. Baltimore, MD: Maryland Department of the Environment. Also Available at [http://www.mde.maryland.gov/programs/Water/TMDL/TMDLHome/Pages/Final\\_Bay\\_WIP\\_2010.aspx](http://www.mde.maryland.gov/programs/Water/TMDL/TMDLHome/Pages/Final_Bay_WIP_2010.aspx).

\_\_\_\_\_. 2011. *Watershed Report for Biological Impairment of Double Pipe Creek Watershed in Carroll and Frederick Counties, Maryland*. Baltimore, MD: Maryland Department of the Environment.

\_\_\_\_\_. 2012. Draft. *Maryland's Phase II Watershed Implementation Plan for the Chesapeake Bay Total Maximum Daily Load*. Baltimore, MD: Maryland Department of the Environment. Also Available at

[http://www.mde.state.md.us/programs/Water/TMDL/TMDLImplementation/Pages/DR\\_AFT\\_PhaseII\\_WIPDocument\\_Main.aspx](http://www.mde.state.md.us/programs/Water/TMDL/TMDLImplementation/Pages/DR_AFT_PhaseII_WIPDocument_Main.aspx).

MGS (Maryland Geological Survey). 2007. *A Brief Description of the Geology of Maryland*. <http://www.mgs.md.gov/esic/brochures/mdgeology.html> (Accessed March, 2012).

Pitt, R., A. Maestre, R., Morquecho, T. Brown, C. Swann, K. Cappiella, and T. Schuler. 2005. Evaluation of NPDES Phase 1 Municipal Stormwater Monitoring Data. Also Available at <http://www.epa.gov/owow/nps/natlstormwater03/28Pitt.pdf>

Roth, N., M. T. Southerland, J. C. Chaillou, R. Klauda, P. F. Kazyak, S. A. Stranko, S. Weisberg, L. Hall Jr., and R. Morgan II. 1998. Maryland Biological Stream Survey: Development of a Fish Index of Biotic Integrity. *Environmental Management and Assessment* 51: 89-106.

Roth, N. E., M. T. Southerland, J. C. Chaillou, P. F. Kazyak, and S.A. Stranko. 2000. *Refinement and Validation of a Fish Index of Biotic Integrity for Maryland Streams*. Columbia, MD: Versar, Inc. with Maryland Department of Natural Resources, Monitoring and Non-Tidal Assessment Division.

Roth, N. E., M. T. Southerland, G. M. Rogers, and J. H. Volstad. 2005. *Maryland Biological Stream Survey 2000-2004: Volume IV: Ecological Assessment of Watersheds Sampled in 2003*. Columbia, MD: Versar, Inc. with Maryland Department of Natural Resources, Monitoring and Non-Tidal Assessment Division.

Stribling, J. B., B. K. Jessup, J. S. White, D. Boward, and M. Hurd. 1998. *Development of a Benthic Index of Biotic Integrity for Maryland Streams*. Owings Mills, MD: Tetra Tech, Inc. with Maryland Department of Natural Resources, Monitoring and Non-Tidal Assessment Program.

USDA (U.S. Department of Agriculture). 1982. *1982 Census of Agriculture*. Washington, DC: United States Department of Agriculture.

\_\_\_\_\_. 1987. *1987 Census of Agriculture*. Washington, DC: United States Department of Agriculture.

\_\_\_\_\_. 1992. *1992 Census of Agriculture*. Washington, DC: United States Department of Agriculture.

\_\_\_\_\_. 1997. *1997 Census of Agriculture*. Washington, DC: United States Department of Agriculture.

\_\_\_\_\_. 2002. *2002 Census of Agriculture*. Washington, DC: United States Department of Agriculture.



US EPA (U.S. Environmental Protection Agency). 1991. *Technical Support Document (TSD) for Water Quality-based Toxics Control*. Washington, DC: U.S. Environmental Protection Agency. Also Available at <http://www.epa.gov/npdes/pubs/owm0264.pdf>.

\_\_\_\_\_. 2002. *Establishing Total Maximum Daily Load (TMDL) Wasteload Allocations (WLAs) for Storm Water Sources and NPDES Permit Requirements Based on Those WLAs*. Washington, DC: U.S. Environmental Protection Agency.

\_\_\_\_\_. 2007. *Options for the Expression of Daily Loads in TMDLs (DRAFT 6/22/07)*. Washington, D.C.: U.S. Environmental Protection Agency, Office of Wetlands, Oceans & Watersheds. Also Available at [www.epa.gov/owow/tmdl/draft\\_daily\\_loads\\_tech.pdf](http://www.epa.gov/owow/tmdl/draft_daily_loads_tech.pdf).

\_\_\_\_\_. 2010a. *Chesapeake Bay Total Maximum Daily Load*. U.S. Environmental Protection Agency, Chesapeake Bay Program Office, Annapolis MD. December 2010.

\_\_\_\_\_. 2010b. *Chesapeake Bay Phase 5.3 Community Watershed Model*. EPA 903S10002 - CBP/TRS-303-10. U.S. Environmental Protection Agency, Chesapeake Bay Program Office, Annapolis MD. December 2010. Also available at <http://ches.communitymodeling.org/models/CBPhase5/documentation.php#p5modeldoc>.

## APPENDIX A – Watershed Characterization Data

Table A-1: Reference Watersheds

MD 8-digit Name	MD 8-digit	Percent Stream Mile Degraded (%) <sup>1,2</sup>	Forest Normalized Phosphorus Load <sup>3,4</sup>
Deer Creek	02120202	11	6.93
Octoraro Creek <sup>5</sup>	02120203	8	10.14
Broad Creek	02120205	12	5.71
Northeast River <sup>5</sup>	02130608	14	7.13
Furnace Bay <sup>5</sup>	02130608	11	7.24
Little Gunpowder Falls <sup>5</sup>	02130804	15	8.22
Prettyboy Reservoir	02130806	16	11.92
Middle Patuxent River <sup>5</sup>	02131106	20	8.29
Brighton Dam	02131108	11	9.94
Sideling Hill Creek	02140510	20	2.38
Fifteen Mile Creek <sup>5</sup>	02140511	4	1.51
Savage River	02141006	7	2.46
<b>Median</b>			<b>7.18</b>
<b>75<sup>th</sup> Percentile</b>			<b>8.71</b>

- Notes:**
- <sup>1</sup> Percent stream miles degraded within an 8-digit watershed is based on the percentage of impaired MBSS stations within the watershed (MDE 2008).
  - <sup>2</sup> The percent stream miles degraded threshold to determine if an 8-digit watershed is impaired for impacts to biological communities is based on a comparison to reference conditions (MDE 2008).
  - <sup>3</sup> Forest normalized phosphorus loads based on Maryland watershed area only (consistent with MBSS random monitoring data).
  - <sup>4</sup> Based on 1991-2000 average annual edge-of-stream loads from CBP Phase 5.3.2 Watershed Model 2009 Progress Scenario and regional average forest yields.
  - <sup>5</sup> Forest normalized phosphorus load does not include process water point sources discharging to mainstem river.

## APPENDIX B – Technical Approach Used to Generate Maximum Daily Loads

### Summary

This appendix documents the technical approach used to define maximum daily loads of phosphorus consistent with the average annual TMDL, which is protective of water quality standards in the Double Pipe Creek watershed. The approach builds upon the modeling analysis that was conducted to determine the loadings of phosphorus and can be summarized as follows.

- The approach defines maximum daily loads for each of the source categories.
- The approach builds upon the TMDL modeling analysis that was conducted to ensure that average annual loading targets result in compliance with water quality standards.
- The approach converts daily time-series loadings into TMDL values in a manner that is consistent with available EPA guidance on generating daily loads for TMDLs.
- The approach considers a daily load level of a resolution based on the specific data that exists for each source category.

### Introduction

This appendix documents the development and application of the approach used to define total maximum daily loads on a daily basis. It is divided into sections discussing:

- Basis for approach,
- Options considered,
- Selected approach,
- Results of approach.

### Basis for approach

The overall approach for the development of daily loads was based upon the following factors:

- **Average Annual TMDL:** The basis of the average annual phosphorus TMDL is that cumulative high nutrient loading rates have negative impacts on the biological community. Thus, the average annual phosphorus loads were calculated to be protective of the aquatic life designated use.
- **CBP P5.3.2 Watershed Model Phosphorus Loads:** As described in Section 2.2.1, the EOS phosphorus loads in the P5.3.2 model are based on (1) median of phosphorus export rates reported in the scientific literature; (2) land segment calibration targets adjusted by nutrient applications in excess of vegetative uptake; and (3) regional factors calculated in the calibration of river segments, where simulated output is compared to observed monitoring data. Riverine processes are calibrated in river segments representing rivers of approximately 100 cfs average annual flow.

- **Draft EPA guidance document entitled “Developing Daily Loads for Load-based TMDLs”:** This guidance document provides options for defining maximum daily loads when using TMDL approaches that generate daily output (EPA, 2007).

The rationale for developing TMDLs expressed as *daily* loads was to accept the existing average annual TMDLs, but then develop a method for converting these numbers to a maximum *daily* load – in a manner consistent with EPA guidance and available information.

### **Options Considered**

The draft EPA guidance document for developing daily loads does not specify a single approach that must be adhered to, but rather it contains a range of acceptable options. The selection of a specific method for translating a time-series of allowable loads into the expression of a TMDL requires decisions regarding both the level of resolution (e.g., single daily load for all conditions vs. loads that vary with environmental conditions) and level of probability associated with the TMDL.

This section describes the range of options that were considered when developing maximum daily loads for the Double Pipe Creek watershed.

#### Level of Resolution

The level of resolution pertains to the amount of detail used in specifying the maximum daily load. The draft EPA guidance on daily loads provides three categories of options for level of resolution, all of which are potentially applicable for the Double Pipe Creek watershed:

1. **Representative daily load:** In this option, a single daily load (or multiple representative daily loads) is specified that covers all time periods and environmental conditions.
2. **Flow-variable daily load:** This option allows the maximum daily load to vary based upon the observed flow condition.
3. **Temporally-variable daily load:** This option allows the maximum daily load to vary based upon seasons or times of varying source or water body behavior.

#### Probability Level

All TMDLs have some probability of being exceeded, with the specific probability being explicitly specified or implicitly assumed. This level of probability directly or indirectly reflects two separate phenomena:

1. Water quality criteria consist of components describing acceptable magnitude, duration, and frequency. The frequency component addresses how often conditions can allowably surpass the combined magnitude and duration components.
2. Pollutant loads, especially from wet weather sources, typically exhibit a large degree of variability over time. It is rarely practical to specify a “never to be exceeded value” for a daily load, as essentially any loading value has some finite probability of being exceeded.

The draft daily load guidance document states that the probability component of the maximum daily load should be “based on a representative statistical measure” that is dependent upon the specific TMDL and best professional judgment of the developers. This statistical measure represents how often the maximum daily load is expected/allowed to be exceeded. The primary options for selecting this level of protection would be:

1. **The maximum daily load reflects some central tendency:** In this option, the maximum daily load is based upon the mean or median value of the range of loads expected to occur. The variability in the actual loads is not addressed.
2. **The maximum daily load reflects a level of protection implicitly provided by the selection of some “critical” period:** In this option, the maximum daily load is based upon the allowable load that is predicted to occur during some critical period examined during the analysis. The developer does not explicitly specify the probability of occurrence.
3. **The maximum daily load is a value that will be exceeded with a pre-defined probability:** In this option, a “reasonable” upper bound percentile is selected for the maximum daily load based upon a characterization of the variability of daily loads. For example, selection of the 95<sup>th</sup> percentile value would result in maximum daily load that would be exceeded 5% of the time.

### **Selected Approach**

The approach selected for defining a daily maximum load for the Double Pipe Creek watershed was based upon the specific data that exists for each source category. The approach consists of unique methods for each of the following categories of sources:

- Approach for Nonpoint Sources and Stormwater Point Sources,
- Approach for Process Water Point Sources,
- Approach for Upstream Loads.

#### Approach for Nonpoint Sources, CAFOs, and Stormwater Point Sources

The level of resolution selected for defining a daily maximum load for the Double Pipe Creek watershed was a representative daily load, expressed as a single daily load for each loading source. This approach was chosen based upon the specific data that exists for nonpoint sources, CAFOs, and stormwater point sources.

Currently, the best available data is the CBP P5.3.2 model daily time series calibrated to long-term average annual loads (per land-use). The CBP reach simulation results are calibrated to daily monitoring information for river reach segments with a flow typically greater than 100 cfs. See US EPA (2010b) for details on the river reach calibration. The calibration of river parameters modifies the EOS input loads to reaches by introducing gains or losses of phosphorus through riverine processes. These gains or losses are associated with the represented reach and therefore the absolute magnitude of the river phosphorus loads are not the appropriate measure of

EOS loads at the subwatershed scale where excess nutrients are associated with biological impairments.

It was concluded that it would not be appropriate to apply the absolute values of the reach simulation model results to the TMDL, but to adopt the methodology of the MD sediment TMDLs which is a statistically-based estimate using the annual loads and the distribution of simulated daily loads. In this approach, it is assumed that, because they are based on the same underlying hydrology, the distribution of the daily simulated river reach loads represents the distribution of delivered EOS loads, in order to calculate a normalized statistical parameter to estimate the maximum daily loads.

The maximum daily load was estimated based on three factors: a specified probability level, the average annual phosphorus TMDL, and the coefficient of variation (CV) of the CBP P5.3.2 Double Pipe Creek reach simulation daily loads. The probability level (or exceedance frequency) is based upon guidance from EPA (US EPA 1991) where examples suggest that when converting from a long-term average to a daily value, the z-score corresponding to the 99<sup>th</sup> percentile of the log-normal probability distribution should be used.

The CBP P5.3.2 Double Pipe Creek reach simulation consisted of a daily time series beginning in 1985 and extending to the year 2005. The CV was estimated by first converting the daily phosphorus load values to a log distribution and then verifying that the results approximated a normal distribution (see Figure B-1). Next, the CV for this distribution was calculated using the arithmetic mean and standard deviation results from the log transformation. The log-transformed values were used to reduce the possible influence of outliers. The resulting CV of 0.476 was calculated using the following equation:

$$CV = \frac{\beta}{\alpha} \quad (\text{Equation B. 1})$$

where

CV = coefficient of variation

$$\beta = \alpha \sqrt{e^{\sigma^2} - 1}$$

$$\alpha = e^{(\mu + 0.5\sigma^2)}$$

$\alpha$  = mean (arithmetic)

$\beta$  = standard deviation (arithmetic)

$\mu$  = mean of logarithms

$\sigma$  = standard deviation of logarithms

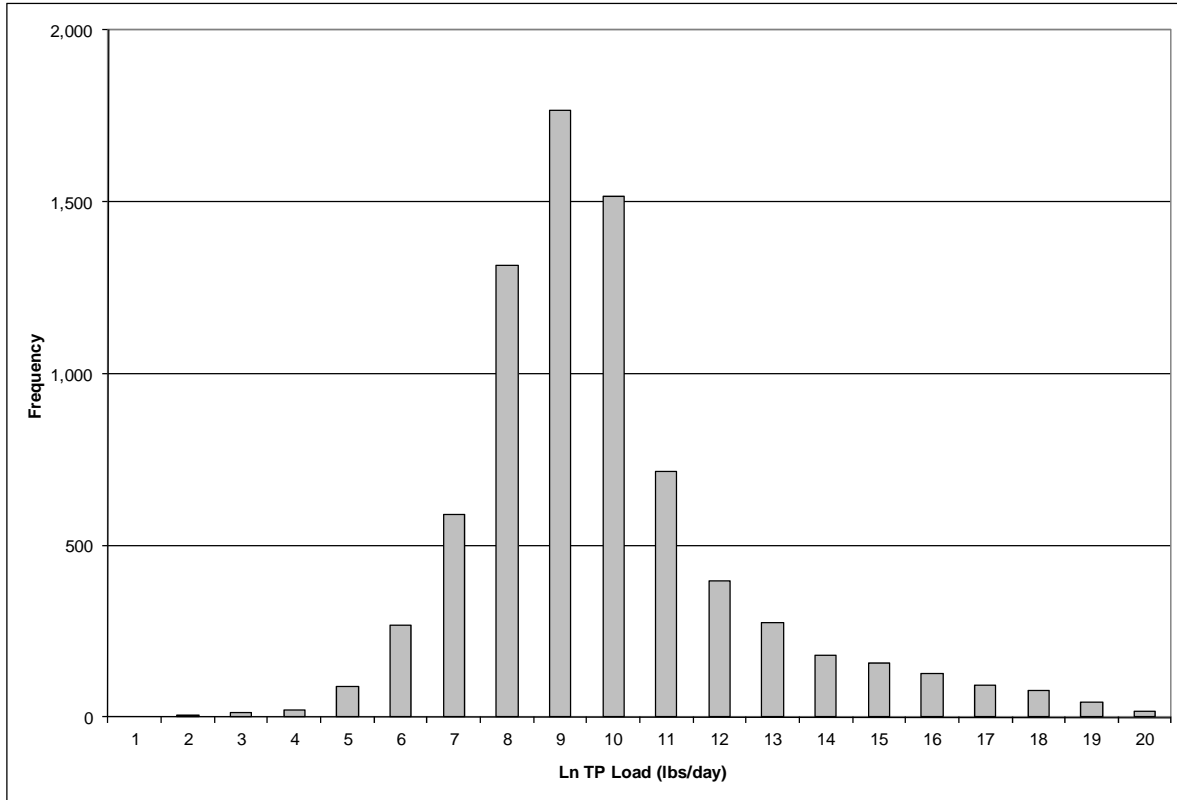

**Figure B-1: Histogram of CBP River Segment Daily Phosphorus Simulation Results for the Double Pipe Creek Watershed**

The maximum “daily” load for each contributing source is estimated as the long-term average annual load multiplied by a factor that accounts for expected variability of daily loading values. The equation is as follows:

$$MDL = LTA * e^{(z\sigma - 0.5\sigma^2)} \quad \text{(Equation B. 2)}$$

where

- MDL = Maximum daily load
- LTA = Long-term average (average annual load)
- Z = z-score associated with target probability level
- $\sigma^2 = \ln(CV^2 + 1)$
- CV = Coefficient of variation based on arithmetic mean and standard deviation.

Using a z-score associated with the 99<sup>th</sup> percent probability, CV of 0.476, and consistent units, the resulting dimensionless conversion factor from long-term average loads to a maximum daily value is 2.585. The average annual Double Pipe Creek phosphorus TMDL is reported in lbs/year, and the conversion from lbs/year to a maximum daily load in lbs/day is 0.007 (*i.e.*, 2.585/365).

### Approach for Process Water Point Sources

The TMDL also considers contributions from other point sources (*i.e.*, sources other than stormwater point sources) in the watershed that have NPDES permits with phosphorus limits. As these sources are generally minor contributors to overall nutrient loads, the TMDL analysis that defined the average annual TMDL did not propose any reductions for these sources and held each of them constant at their existing technology-based NPDES permit monthly (or daily if monthly was not specified) limit for the entire year.

The approach used to determine maximum daily loads for these sources was dependent upon whether a maximum daily load was specified within the permit. If a maximum daily limit was specified, then the reported average flow was multiplied by the daily maximum limit to obtain a maximum daily load. If a maximum daily limit was not specified, the maximum daily loads were calculated based on the guidance provided in the Technical Support Document (TSD) for Water Quality-based Toxics Control (US EPA 1991). The long-term average annual TMDL was converted to maximum daily limits using Table 5-2 of the TSD assuming a coefficient of variation of 0.6 and a 99<sup>th</sup> percentile probability. This results in a dimensionless multiplication factor of 3.11. The average annual Double Pipe Creek phosphorus TMDL are reported in lbs/year, and the conversion from lbs/year to a maximum daily load in lbs/day is 0.0085 (e.g. 3.11/365).

In the case of Double Pipe Creek, all permitted sources with phosphorus concentration limits have no permitted daily maximum concentrations, so the maximum daily load was calculated based on the TSD guidance.

### Margin of Safety

As explained in Section 4.7, an implicit margin of safety (MOS) is used in the Double Pipe Creek Phosphorus TMDL.

### **Results of Approach**

This section lists the results of the selected approach to define maximum daily loads for the Double Pipe Creek watershed.

- Calculation Approach for Nonpoint Sources, CAFOs, and Stormwater Point Sources,
- $LA \text{ (lbs/day)} = \text{Average Annual TMDL LA (lbs/yr)} * 0.007,$
- $\text{Stormwater WLA (lbs/day)} = \text{Average Annual TMDL Stormwater WLA (lbs/yr)} * 0.007,$
  
- Calculation Approach for Process Water Point Sources
  - For permits with a daily maximum limit:



FINAL

Process Water WLA (lbs/day) = Permit flow (MGD) \* Daily maximum permit limit (mg/l) \* 0.0042.

- o For permits without a daily maximum limit:

Process Water WLA (lbs/day) = Process Water WLA (lbs/yr)\* 0.0085.

**Table B-1: Summary of Maximum Daily Loads of Total Phosphorus for the Double Pipe Creek Watershed (lbs/day)**

TMDL (lbs/day)	=	LA		+	WLA			+	MOS			
		LA <sub>DPC</sub>	+	Septic		CAFO WLA <sub>DPC</sub>	+	NPDES Stormwater WLA <sub>DPC</sub>		+	Process Water WLA <sub>DPC</sub>	
<b>918</b>	=	797	+	0	+	3	+	64	+	54	+	Implicit

**APPENDIX C – Hydrologic Relationship between the Double Pipe Creek, Upper Monocacy River, and Lower Monocacy River Watersheds**

The purpose of this appendix is to explain the hydrologic relationship between the Double Pipe Creek, Upper Monocacy River, and Lower Monocacy River watersheds. As illustrated in Figure C-1, the three watersheds are hydrologically connected, beginning with the Double Pipe Creek watershed to the east. The Double Pipe Creek flows into the Upper Monocacy River near the town of Rocky Ridge. It is also shown in Figure C-1 that the Upper Monocacy River watershed includes land in Pennsylvania and Maryland. The combined flow from the Upper Monocacy River and the Double Pipe Creek flows into the Lower Monocacy River. The hydrologic connectivity of the watersheds is illustrated in Figure C-2.

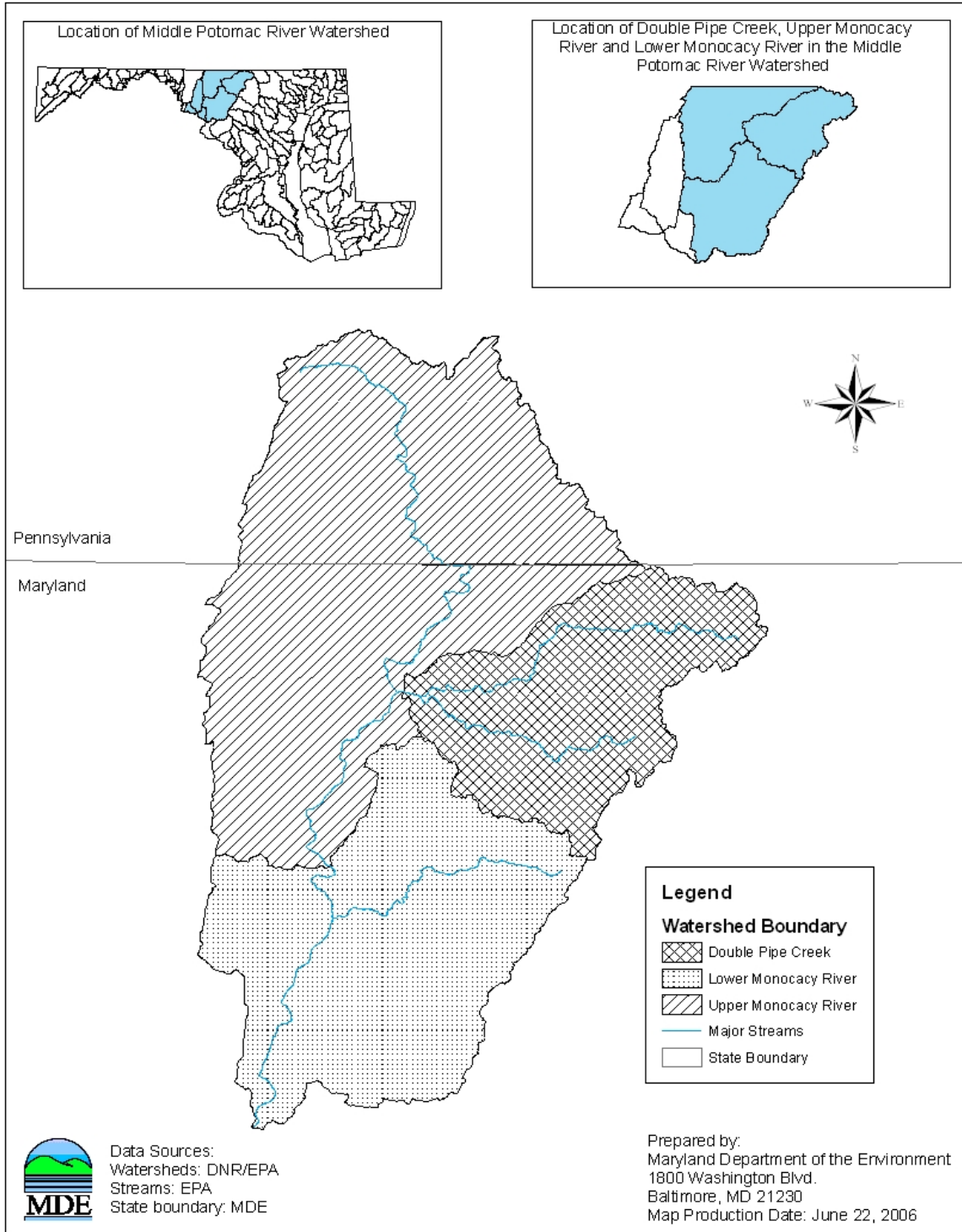

**Figure C-1: Location of the Double Pipe Creek, Upper Monocacy River, and Lower Monocacy River Watersheds**

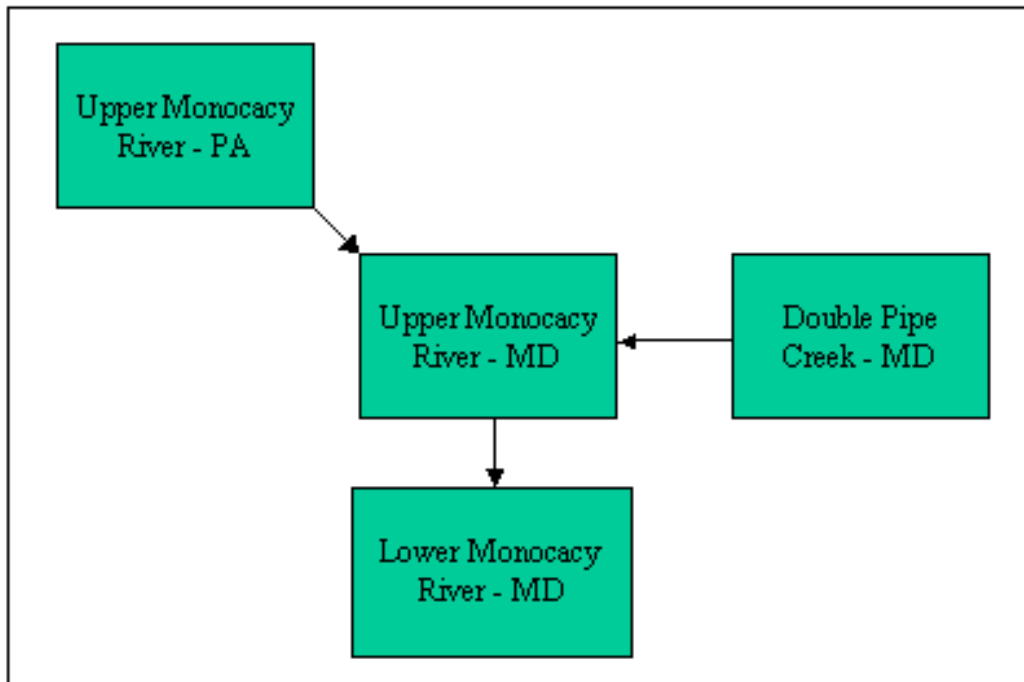

**Figure C-2: Flow Schematic of the Double Pipe Creek, Upper Monocacy River, and Lower Monocacy River Watersheds**