



# Maryland

## Department of the Environment

Larry Hogan, Governor  
Boyd K. Rutherford, Lt. Governor

Ben Grumbles, Secretary  
Horacio Tablada, Deputy Secretary

April 13, 2022

Maryland Port Administration  
C/o Maryland Environmental Service  
Attention: Maura Morris  
259 Najoles Road  
Millersville, MD 21108-2515

Via email: [mmorris@menv.com](mailto:mmorris@menv.com)

Re: Agency Interest Number: 163561  
Tracking Number: 202160895  
Water Quality Certification Number: 21-WQC-0331  
Tidal Authorization Number: 21-WL-0640

Dear Maryland Port Administration:

Your project did not qualify as a type of project that is covered by the Maryland State Programmatic General Permit (MDSPPG) and its associated 401 Water Quality Certification (WQC). This project is an U.S. Army Corps of Engineers (USACE) civil works project authorized under the Water Resources Reform and Development Act of 2014. Because this is a USACE civil works project, there is no USACE regulatory program permit. However, an individual 401 WQC is necessary for this project in accordance with section 401 of the Clean Water Act and USACE interpretation of section 401 of the CWA with regard to its applicability to USACE civil works projects.

Your project also requires a Wetlands License to be approved and issued by the Maryland Board of Public Works (BPW). The Wetlands License will be sent to you by BPW's Wetlands Administrator.

The individual Water Quality Certification (WQC) for this project issued by the Maryland Department of the Environment is attached. Please share with the USACE as they are subject to certain conditions. MPA and the USACE should read and review the WQC for the project to ensure that MPA and the USACE understand the limits of the authorized work and all of the general and special conditions.

You should not begin any work until you have obtained all necessary State, local, and federal authorizations. Please contact Mary Phipps-Dickerson at [mary.phipps-dickerson@maryland.gov](mailto:mary.phipps-dickerson@maryland.gov) or 410-901-4033 with any questions.

Sincerely,

*Heather L. Nelson*

Tammy K. Roberson  
Chief  
Tidal Wetlands Division

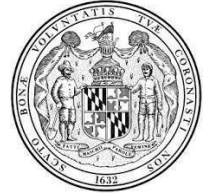

STATE OF MARYLAND  
DEPARTMENT OF THE ENVIRONMENT  
WATER AND SCIENCE ADMINISTRATION  
WATER QUALITY CERTIFICATION

21-WQC-0331

EFFECTIVE DATE: **April 13, 2022**  
EXPIRATION DATE: **April 13, 2052**  
CERTIFICATION REQUESTOR: **Maryland Port Administration**  
ADDRESS: **Attn: Amanda Penafiel**  
**401 E. Pratt Street, Ste 1900**  
**Baltimore, MD 21202**  
PROJECT LOCATION: **off Hoopers Island shoreline**  
**Fishing Creek, MD 21634**

The Barren Island component of the Mid-Chesapeake Bay Island Ecosystem Restoration Project (Mid-Bay Island Project) is an ecosystem restoration and beneficial use of dredged material project. Construction of the Mid-Bay Island Project in Dorchester County, Maryland was authorized by Section 7002 of the Water Resources Reform and Development Act of 2014, Public Law 113-121. Dredged material from local federally maintained navigation channels will serve as the material to stabilize Barren Island, restore wetlands, and thereby provide for the conditions for submerged aquatic vegetation (SAV) habitat east of Barren Island. The Mid-Bay Island Project, which includes the Barren Island component, is an integral component of the Federal Dredged Material Management Plan, as well as Maryland State's Dredged Material Management Plan, which is the long-term regional plan for managing sediments from the Chesapeake Bay Federal navigation channels. The Mid-Bay Island Project has been planned, and will be implemented, through the cooperative efforts of Federal and State agencies.

On December 17, 2021 the U.S. Army Corps of Engineers (USACE), Baltimore District, in partnership with the Maryland Department of Transportation Maryland Port Administration (MDOT MPA), the project's non-federal sponsor for the Mid-Bay Island Project at Barren Island, prepared and released for public comment its draft supplemental Environmental Assessment (sEA). The document was finalized, and a Finding of No Significant Impact (FONSI) was issued on March 7, 2022. Section 7002 of the Water Resources Reform and Development Act of 2014 authorized the Mid-Bay Island Project, as described in the Chief's Report dated August 24, 2009 and the Mid-Chesapeake Bay Island Ecosystem Restoration Integrated Feasibility Report and Environmental Impact Statement (EIS), dated June 2009. The record of decision was signed in July 2019. The sEA serves to update National Environmental Policy Act (NEPA) compliance during the Preconstruction Engineering and Design phase, prior to construction of the Barren Island portion of the project.

The sEA evaluated impacts, including water quality-related impacts, and benefits associated with the design for the Barren Island portion of the project. This Section 401 State Water Quality Certification (401 WQC) is being issued for work to be conducted in association with the Barren Island component of the Mid-Bay Island Project. The sEA includes the USACE October 2021 Section 404(b)(1) Evaluation of the project which summarizes water quality impacts, states that MPA applied for a 401 WQC on behalf of the Barren Island component of the Mid-Bay Island Project, and includes a statement that the proposed Barren Island component project will comply with state water quality standards. MDE and USACE agree that, regardless of the named requester of the 401 WQC for this proposed USACE Civil Works Project (in this case the named requestor is MDOT MPA), both the USACE and MDOT MPA, the project sponsors, are required to comply with conditions in this 401 WQC which MDE has determined to be necessary to comply with state water quality

standards for those activities performed by the USACE, and its contractors, associated with the Barren Island component of the Mid-Bay Island Project.

**Coastal Zone Management Act:** The Maryland Department of the Environment has determined that the proposed activities comply with, and will be conducted in a manner consistent with the State’s Coastal Zone Management Program, as required by Section 307 of the Federal Coastal Zone Management Act of 1972, as amended, when conducted in accordance with the conditions of this Water Quality Certification.

### **WATER QUALITY CERTIFICATION**

**UNDER AUTHORITY OF SECTION 401 OF THE FEDERAL WATER POLLUTION CONTROL ACT AND ITS AMENDMENTS AND IN ACCORDANCE WITH § 9-313 THROUGH § 9-323, INCLUSIVE, OF THE ENVIRONMENT ARTICLE, ANNOTATED CODE OF MARYLAND, THE MARYLAND DEPARTMENT OF THE ENVIRONMENT, WATER AND SCIENCE ADMINISTRATION HAS DETERMINED THAT THE REGULATED ACTIVITIES DESCRIBED IN THE REQUEST FOR CERTIFICATION FOR THE PROPOSED BARREN ISLAND ECOSYSTEM AND RESTORATION PROJECT AND AS DESCRIBED IN THE ATTACHED PLAN SHEETS DATED APRIL 11, 2022 AND ANY SUBSEQUENT MODIFICATIONS APPROVED BY THE DEPARTMENT WILL NOT VIOLATE MARYLAND’S WATER QUALITY STANDARDS, IF CONDUCTED BY ANY PERSON OR ENTITY PERFORMING AUTHORIZED WORK UNDER THIS CERTIFICATION IN ACCORDANCE WITH THE CONDITIONS OF THIS CERTIFICATION.**

THIS CERTIFICATION DOES NOT RELIEVE THE APPLICANT, OR ANY OTHER PERSON OR ENTITY PERFORMING ACTIVITIES RELATED TO THE PROPOSED PROJECT, OF RESPONSIBILITY FOR OBTAINING ANY OTHER APPROVALS, LICENSES, OR PERMITS IN ACCORDANCE WITH FEDERAL, STATE, OR LOCAL REQUIREMENTS AND DOES NOT AUTHORIZE COMMENCEMENT OF THE PROPOSED PROJECT. A COPY OF THIS REQUIRED CERTIFICATION HAS BEEN SENT TO THE CORPS OF ENGINEERS. THE CERTIFICATION HOLDER SHALL COMPLY WITH THE CONDITIONS LISTED BELOW.

### **PROJECT DESCRIPTION**

Restore 83 acres of wetlands, construct approximately 13,023 linear feet of new and modified stone sills and approximately 4,620 linear feet of segmented breakwater, install two bird nesting habitat islands totaling 8.5 acres. Approximately 52,500 cubic yards of material that is unsuitable for construction foundation will be dredged from the northeast Barren Island stone sill location to an approximate depth of 7 feet and will be placed hydraulically or mechanically within the confined area behind the constructed stone sills at Barren Island. Approximately 429,000 cubic yards of dredged material from small authorized local federal navigation channels will be placed behind the confining stone sills up to the mean high water elevation to construct the wetlands. Dredged material for wetland construction will be placed within containment dikes that prohibit the egress of material into Chesapeake Bay waters. No direct connection to surface waters by dredged material will occur during the placement of dredged material. Decanted water will be released in compliance with discharge conditions. Wetlands will include low and high marsh plantings as well as intertidal mudflats. During final wetland planning, current conditions will be evaluated with respect to sea level rise projections and determinations of sustainable marsh elevations to identify high to low marsh ratios.

## **GENERAL CONDITIONS**

1. This Certification does not obviate the need to obtain required authorizations or approvals from other State, federal or local agencies as required by law.
2. All additional authorizations or approvals, including self-certifying General Permits issued by the Department, shall be obtained and all conditions shall be completed in compliance with such authorizations.
3. The proposed project shall be constructed in accordance with the approved final plan by the Department, or, if Department approval is not required, the plan approved by the U.S. Army Corps of Engineers; and its approved revisions.
4. All fill and construction materials not used in the project shall be removed and disposed of in a manner which will prevent their entry into waters of this State.
5. This Certification does not authorize any injury to private property, any invasion of rights, or any infringement of federal, state, or local laws or regulations.
6. Authorized representatives of the Department shall be provided access to the site of authorized activities during normal business hours to conduct inspections and evaluations of the operations and records necessary to assure compliance with this Certification.
7. Authorized work under this Certification shall be performed in accordance with the required Soil Erosion and Sediment Control Plan as approved by the Maryland Department of the Environment.
8. No stockpiles of any material shall be placed in Waters of the U.S. or state or private tidal wetlands.
9. Temporary construction trailers or structures, staging areas and stockpiles shall not be located within tidal wetlands, nontidal wetlands, nontidal wetlands buffers, or the 100-year floodplain unless specifically included on the Approved Plan.
10. This Certification is valid for the project identified herein and the associated U.S. Army Corps of Engineers civil works project approved in the Water Resources Reform and Development Act of 2014 until such time that it expires or is not administratively extended.

## **SPECIAL CONDITIONS**

1. All water quality-related performance standards and conditions required by the Department in any state issued authorization for activities in tidal wetlands, nontidal waterways, their 100-year floodplains, nontidal wetland buffers, or nontidal wetland expanded buffers to ensure that any discharges will not result in a failure to comply with water quality standards in COMAR 26.08.02. or other water quality requirements of state law or regulation shall be met.
2. All Critical Area requirements shall be followed and all necessary authorizations from the Critical Area Commission ("Commission") shall be obtained. This Certificate does not constitute authorization for disturbance in the 100-foot Critical Area Buffer. "Disturbance" in the Buffer means clearing, grading, construction activities, or removal of any size of tree or vegetation. Any anticipated Buffer disturbance requires prior written approval, before commencement of land disturbing activity, from the Commission in the form of a Buffer Management Plan.

3. All work performed under this Water Quality Certificate shall be conducted by a marine contractor licensed by the Marine Contractors Licensing Board (MCLB) in accordance with Title 17 of the Environment Article of Annotated Code of Maryland. Licensing by MCLB shall occur prior to the beginning of construction activities. A list of licensed marine contractors may be obtained by contacting the MCLB at 410-537- 3249, by e-mail at MDE.MCLB@maryland.gov or by accessing the Maryland Department of the Environment, Environmental Boards webpage.
4. A detailed plan for monitoring water quality parameters associated with construction and operation of the restoration site shall be submitted to the Maryland Department of the Environment, Tidal Wetlands Division, prior to project commencement. Written approval of the monitoring plan from the Tidal Wetlands Division shall be received prior to project commencement.
5. Monitoring required by any Department authorization shall be conducted in compliance with the approved monitoring plan to ensure that water quality standards and water quality requirements for waters of this State are met.
6. Monitoring of the suspended solids content in the discharge from the hydraulically dredged material placement areas shall be conducted. The suspended solids shall not exceed a monthly average of four hundred parts per million with a daily maximum of 800 parts per million.
7. Monitoring of the turbidity in the surface water resulting from any discharge or fill placement shall be conducted. Levels may not exceed 150 Nephelometer Turbidity Units (NTU) at any time or 50 NTU as a monthly average outside the “mixing zone” as established in the monitoring plan. A turbidity curtain shall be deployed in the event that turbidity readings exceed the identified thresholds.
8. Discharges from spillways shall have a velocity no greater than four feet per second in order to prevent erosion in the receiving waterway or wetland.
9. An inadvertent breach response plan to outline actions to be taken in the event of a breach shall be developed. The plan shall be provided to the Maryland Department of the Environment and approved prior to commencement of any dredged material placement activities authorized by this Certification.
10. Prior to the start of work a copy of the final, approved Erosion and Sediment Control Plans shall be provided to the Wetlands and Waterways Program, Tidal Wetlands Division.
11. As-built plans will be provided to MDE Water and Science Division within 90 days of completion of the placement of breakwaters.
12. The dredged material shall be sampled in accordance with the February 1998 EPA “Evaluation of Dredged Material Proposed for Discharge in Waters of the U.S. - Testing Manual: Inland Testing Manual”. Results of these samples shall be provided to MDE. Dredged material that does not meet the criteria of the Inland Testing Manual shall not be placed on Barren Island.
13. Material dredged from within the Patapsco River inside the North Point – Rock Point line is not authorized to be deposited at Barren Island due to the potential for contaminated sediments. These channels include a portion of the Brewerton Channel, Curtis Bay Channel, Fort McHenry Channel, East, West, and Ferry Bar Channels.
14. When unloading dredged material, the dredger shall have a person at the discharge point of the DMP in constant radio communication. If a problem is incurred, the placement of dredged material shall be immediately shut down until the reason for the problem can be ascertained and rectified.
15. Inspections shall be conducted of the permitted area after the first earth disturbance occurs on the site, and thenceforth during the entire period of Certification coverage whether the site is active or inactive. The person(s) inspecting the site may be a person on the Certificate Holder staff or a third party hired or arranged to conduct inspections. The person conducting the inspection must hold a valid certificate

of attendance at training program for responsible personnel as required by Section 4-104(b) of the Environment Article, unless the erosion and sediment control plan approval authority has waived the requirement for a Certificate of Training in accordance with Section 4-104(c) of the Environment Article. During times that work is being conducted at the site, Inspections shall be conducted at the following intervals: a. Once each calendar week (Sunday to Saturday), except as in c; b. The next day after a rainfall event resulting in runoff, except as in c; c. For areas meeting stabilization requirements of COMAR 26.17.01.07.B.6 (f) and the erosion and sediment control plan, once per month. (If construction activity resumes in such a portion of the site at a later date, the inspection frequency immediately increases to that required in a and b. The beginning and ending dates of the period of stabilization shall be documented in its inspection records).

16. Written reports of all inspections conducted under Special Condition #15 of this Certification shall be kept on file and be made available to WSA within one business day of a request for the records. The report shall include: (1) the date and time of the inspection; (2) the name(s) of the individual(s) who performed the inspection; (3) an assessment of the condition of erosion and sediment controls and how any deficiencies were or are being addressed; (4) a description and date of any erosion and sediment control implementation and maintenance performed, including identification of any controls that have not been installed as required; and (5) a description of the site's present phase of construction.
17. Dredged material pipelines shall be installed, marked and maintained in accordance with all U.S. Coast Guard requirements for navigational safety. Dredge material pipelines and associated equipment shall be removed as soon as practicable, upon completion of activities authorized under this License.
18. Activities involved in the restoration of Barren Island shall follow enforceable state policies and specific management requirements developed through the Interagency Working Group related to fish passage, protection and management of submerged aquatic vegetation, protection of oyster bars, protection of shellfish aquaculture leases, prohibition of genetically modified organisms, and control of nonnative aquatic organisms.
19. Adherence to the construction time of year restrictions, unless waived or amended by the Department, as identified in a state authorization shall be followed.
20. Coordination with the Department of Natural Resources (DNR) shall be completed to determine whether proposed work will impact active oyster leases, and notify any identified leaseholder(s) at least 30 days prior to commencement of work so that aquaculture gear and product may be relocated by the leaseholder as they determine necessary to avoid oyster loss or damage during construction. Natural Resources Article §4-11A-16 establishes that a person, other than the leaseholder, may not willfully and without authority catch, willfully destroy, remove, alter or transfer any marker, shellfish, equipment, or structures on any aquaculture or submerged land lease area.
21. The stone breakwaters and sills shall be designed and constructed to prevent the loss of fill material to waters of the State of Maryland.
22. A marsh maintenance plan shall be submitted to and approved by the Tidal Wetlands Division, Water and Science Administration, and any alternative plan must be submitted to and approved by the Tidal Wetlands Division, Water and Science Administration, prior to commencement of any wetland restoration or planting activities. Any alternative plan must provide assurances of success that are at least equivalent to those of the standard plan, in terms of the extent of native marsh plant coverage, elimination of invasive species and timeframe for plant establishment.
23. Authorized work under this Certification shall be constructed in the marsh establishment area in accordance with the following conditions:
  - a) The marsh establishment area shall be planted within one year following completion of sediment management operations. Areas to be managed as mud flats and channels/open water will not be vegetated.

- b) The marsh establishment project shall be maintained as a wetland, with non-nuisance species' areal coverage of at least 85% of the planted areas for three consecutive years. If 85% coverage is not attained, the reasons for failure shall be determined, corrective measures shall be taken, and the area shall be revegetated in accordance with the approved Adaptive Management Plan.
  - c) If the existing bank is to be cleared or graded:
    - 1) Any person or entity performing authorized work under this Certification shall perform all work under and in accordance with an approved Soil Erosion and Sediment Control Plan from the applicable sediment and erosion control agency; and
    - 2) Work authorized under this Certification shall perform all work under and in accordance with the Critical Area requirements of the Critical Area Commission in the form of an approved Buffer Management Plan.
  - d) Monitoring Reports. Monitoring reports shall be submitted annually. The reports shall include the extent of native marsh plant coverage, elimination of invasive species and timeframe for plant establishment, and include photographs for the first five growing seasons in order to document the success of the project in terms of the extent of native marsh plant coverage. Photographs shall be taken from at least two directions, as necessary to fully depict the wetlands and bird island habitat.
24. An Adaptive Management Plan shall be developed through coordination with interested agencies including MDE, DNR, United States Army Corps of Engineers, Environmental Protection Agency, National Marine Fisheries Service, US Fish and Wildlife Service and other state and federal agencies that request to participate. Habitat design including goals for types of habitat such as upland dunes, nontidal wetlands, tidal wetlands, mudflats, shallow water habitat will be described in this plan, which shall receive approval from the established Interagency Working Group prior to beginning habitat construction or modification. The Certification shall implement the Adaptive Management Plan approved by the participating agencies.
25. Prior to the initiation of work authorized under this Certification, a SAV Monitoring Plan shall be provided to the Water and Science Administration, Tidal Wetlands Division, to assess the 1,325 acres of SAV habitat identified as benefitting from the project and determine the project's effect on SAV acreage and function. The SAV monitoring plan will receive final concurrence from the Interagency Working Group prior to implementation. The area to be monitored shall include the 1,325-acre area of SAV habitat to the east of Barren Island proposed to be protected by construction of the project, in order to determine if adjacent SAV has been impacted. Reference sites outside the potential zone of effects should also be monitored to help differentiate between construction effects and any regional changes that may affect SAV survival. The rolling 5-year composite of aerial data provided by VIMS shall be used to establish presence of SAV within the area. Periodic, once every 5 years, field efforts will be undertaken to sub-sample SAV habitat east of Barren Island to ground-truth VIMS data and to determine species density and diversity.
26. Annual monitoring of the entire project site shall be conducted, and an annual report shall be submitted to the Water and Science Administration, Tidal Wetlands Division during construction and for a period of 5 years after completion of the project in accordance with the approved SAV Monitoring Plan to determine if there are SAV losses or degradation of SAV resulting from the Barren Island Restoration Project which require adaptive management. If it is determined that any component of the project adversely affects SAV habitat, adaptive management shall be implemented in accordance with the Adaptive Management Plans approved by the Water and Science Administration, Tidal Wetlands Division.
27. Coordination shall be conducted with the Water and Science Administration, Tidal Wetlands Division, DNR and Maryland Historical Trust and other interested agencies to identify potential borrow areas

and determine suitability for use for this project.

### **CITATIONS AND STATEMENTS OF NECESSITY**

#### 1) General Authorities; Need for Other Permits

##### a) General Conditions 1, 2, 10; Special Conditions 2, 10

Statement of Necessity for Condition: The condition is necessary to ensure that water quality standards are met under unique circumstances for discharges which may otherwise qualify under the certified Nationwide Permits and to maintain designated uses of waters.

Citation: Federal and state laws that authorize this condition include but are not limited to: 33 U.S.C. § 1341(a), (b), & (d); 33 U.S.C. § 1251(b); 33 U.S.C. § 1370; Md. Ann. Code, Env. Article, Title 1, Subtitles 3 and 4; Md. Ann. Code, Env. Article, Title 5, Subtitles 5 and 9; Md. Ann. Code, Env. Article, Title 9, Subtitle 3; Md. Ann. Code, Env. Article, Title 16; COMAR 26.08; COMAR 26.08.02.10G(3); COMAR 26.23.02.06; COMAR 26.17.01; COMAR 26.23; COMAR 26.24

##### b) General Condition 3

Statement of Necessity for Condition: The condition is necessary to ensure that water quality standards are met under unique circumstances for discharges which may otherwise qualify under the terms of the federal authorization and to maintain designated uses of waters. The Corps of Engineers authorization and plans include details about amount and location of discharges, as well as other conditions for reducing adverse effects to water quality, which ultimately supports maintaining designated uses. The Certification conditions and decision are based upon based on the details of the Corps of Engineers authorization and plans.

Citation: COMAR 26.08.02.01E(2)

##### c) General Condition 5

Statement of Necessity for Condition: The condition is necessary to clarify the scope of this certification to ensure compliance with water quality regulations, without limiting restrictions through other requirements.

Citation: Federal and state laws that authorize this condition include but are not limited to: 33 U.S.C. § 1341(a), (b), & (d); 33 U.S.C. § 1251(b); 33 U.S.C. § 1370; Md. Ann. Code, Env. Article, Title 1, Subtitles 3 and 4; Md. Ann. Code, Env. Article, Title 5, Subtitles 5 and 9; Md. Ann. Code, Env. Article, Title 9, Subtitle 3; Md. Ann. Code, Env. Article, Title 16; COMAR 26.08, COMAR 26.08.02.10E; COMAR 26.23.02.06; COMAR 26.17.04; COMAR 26.23; COMAR 26.24

#### 2) Unauthorized or Incidental Discharges - General Conditions 4, 8, 9, Special Condition 21

Statement of Necessity for Condition: Fill or construction material within or adjacent to regulated resources may cause discharges resulting in turbidity in excess of water quality standards and interfere with designated uses of growth and propagation of fish, other aquatic life, wildlife; and other designated uses; and fail to meet general water quality criteria that waters not be polluted by substances in amounts sufficient to be unsightly or create a nuisance.

Citation: 26.08.02.03B(1)-B(2); COMAR 26.23; COMAR 26.24; COMAR 26.17.04

#### 3) Inspections and Compliance - General Condition 6, Special Conditions 11, 15, 16



Statement of Necessity for Condition: Conditions of certification involve precise actions to comply with water quality standards. Site inspection may be necessary to ensure that limits, methods, and other requirements are met to ensure that water quality standards are met and designated uses are maintained. These conditions are necessary to ensure that the activity was conducted and project completed according to terms of the authorization/certification, while allowing for review of in-field modifications which may have resulted in discharges to ensure that water quality standards were met. Designated uses include support of estuarine and marine aquatic life and shellfish harvesting and forr growth and propagation of fish, other aquatic life, and wildlife

Citation: Federal and state laws that authorize this condition include but are not limited to: 33 U.S.C. § 1341(a), (b), & (d); 33 U.S.C. § 1251(b); 33 U.S.C. § 1370; Md. Ann. Code, Env. Article, Title 1, Subtitles 3 and 4; Md. Ann. Code, Env. Article, Title 5, Subtitles 5 and 9; Md. Ann. Code, Env. Article, Title 9, Subtitle 3; Md. Ann. Code, Env. Article, Title 16; COMAR 26.08; COMAR 26.08.02.03B(1)(b); COMAR 26.08.02.03B(2); COMAR 26.23.02.06; COMAR 26.23; COMAR 26.24; COMAR 26.17.04

#### 4) Erosion and Sediment Control – General Conditions 1, 2, 7; Special Conditions 8, 10

Statement of Necessity for Condition: Erosion and sediment control plans are necessary to ensure that sediment discharges from construction activities will not enter waters of the United States. Sediment discharges from earth disturbance or discharges at erosive rates within or adjacent to regulated resources may cause discharges resulting in turbidity in excess of water quality standards and interfere with designated uses of growth and propagation of fish, other aquatic life, wildlife; and other designated uses; and fail to meet general water quality criteria that waters not be polluted by substances in amounts sufficient to be unsightly or create a nuisance

Citation: Env. Article, Title 4, Subtitle 1 COMAR 26.17.01; 26.08.02.03B(1)-B(2)

#### 5) Performance Standards for Water Quality - Special Condition 1

Statement of Necessity for Condition: This condition is necessary to ensure that discharges will be conducted in a manner which does not violate water quality criteria nor interfere with designated uses.

Citation: COMAR 26.08.02.03B(1)(b); 26.08.02.03B(2);

#### 6) Licensed Marine Contractor - Special Condition 3

Statement of Necessity: Expertise for conducting certain activities is required to ensure that there is no violation of water quality standards nor interference with designated uses.

This condition is necessary to ensure that discharges will be conducted in a manner which does not violate water quality criteria nor interfere with designated uses.

Citation: COMAR 26.08.02.02B(2)- B(4); COMAR 26.08 02.03B(2)(d) – (e); COMAR 26.08.02.03B(1)(b); 26.08.02.03B(2); COMAR 23.02.04.04

#### 7) Monitoring - Special Conditions 4-7, 12

Statement of Necessity: Activities which result or may result in a discharge to regulated waters, including replacement of wetland/water resources as an offset/mitigation may require monitoring to ensure that water quality standards are met and designated uses are maintained, and to determine if remedial measures are needed to restore compliance with water quality standards if they are not met as a result of the discharge. The condition is necessary to ensure that dredged material does not increase turbidity in violation of general and numeric water quality standards and interfere with designated uses and to ensure that offsets to regulated waters are successfully implemented.

Citation: COMAR 26.08.02.03-3A(5); COMAR 26.08.02.03-3(C(5); COMAR 26.08.02.01B(2); COMAR 26.08.02.02B(1) COMAR 26.08.02.02B(3); COMAR 26.08.02.03B; COMAR 26.08.02.02B(1);

26.08.02.03B(1)(b); 26.08.02.03B(2)(e); 26.08.02; 26.08.01.02A; 26.08.02.09A; 26.08.02.02B(1)(d); COMAR 26.24; 26.08.02.03-3C(9)(a); COMAR 26.08.02.03B(2); COMAR 26.08.02.02B(1)(d);

#### 8) Inadvertent discharges - Special Conditions 9, 14, 22

Unauthorized discharges may enter regulated waters as result of activity or structural failure. A plan to address inadvertent discharges will prevent or address further violations of water quality standards and failure of water to meet designated uses, including uses of growth and propagation of fish, other aquatic life, wildlife; and other designated uses; and fail to meet general water quality criteria that waters not be polluted by substances in amounts sufficient to be unsightly or create a nuisance.

Citation COMAR 26.08.02.02B(1)d; COMAR 26.08.02.02B(3); COMAR 26.08.02.03B(1) and B(2); 26.08.02.01B(2); 26.08.02.02B(1)

#### 9) Prevention of Toxic Discharges - Special Conditions 12, 13

Statement of Necessity for Condition: This condition is necessary to prevent contaminated sediments with toxic material in excess of numeric limits to enter regulated waters. Limits or prohibitions are necessary to protect all designated uses.

Citation: COMAR 26.08.02.03-1; COMAR 26.08.02.02

#### 10) Navigational Safety - Special Condition 17

Statement of Necessity for Condition: The condition is necessary to ensure that the discharge does not interfere with designated uses for water contact recreation and fishing nor create a nuisance.

Citation: COMAR 26.08.02.01B(1) and B(2); COMAR 26.08.02.03B(1)(a); COMAR 26.08.02.03B(2)(d)

#### 11) Nuisance and Non-Native Species; SAV, Fish passage; Protection of Oyster Bars and Shellfish Leases – Special Conditions 18, 20, 30

Statement of Necessity for Condition: Nuisance or non-native species may spread and disrupt and dislodge native species from their habitat, leading to declines in distribution, density, growth and propagation. SAV are a critical habitat for many aquatic species. Limitations on loss will sustain habitat for a variety of aquatic species, including anadromous fish and threatened or endangered species. Water quality regulations state minimum thresholds for SAV in tidal waterways. In addition to direct loss, turbidity created by construction or ongoing operation must be limited for support of aquatic life and meet water quality standards.

Oyster bar creation supports/expands designated use for growth and propagation of oyster bars in Support of designated uses for growth and propagation of fish, other aquatic life, and wildlife and the designated use for support of estuarine and marine aquatic life and shellfish harvesting.

The conditions are necessary to allow for continued oyster harvesting and propagation; and maintain and not interfere the designated use- support of estuarine and marine aquatic life and shellfish harvesting.

The conditions ensure that discharges will not result in failure to support designated uses for marine and estuarine aquatic life and submerged aquatic vegetation; and growth, propagation of fish, other aquatic life, and wildlife, and shellfish harvesting.

Citation: COMAR 26.08.02.02-1; COMAR 26.08.02.02B(1)(d); COMAR 26.08.02.03B; COMAR 26.08.02.03-3C; COMAR 26.08.02.02B(2)-B(4); COMAR 26.08 02.03B(2)(d) – (e ); COMAR 26.08.02.03-3C; COMAR 26.08.02.02-1

#### 12) Time of Year Restriction for Conducting Activities – Special Condition 19

Statement of Necessity for Condition: The time of year restriction is necessary to maintain the designated use- support of estuarine and marine aquatic life and shellfish harvesting.

Citation: COMAR: 26.08.02.02B(1)(d); 26.08.02.02B(3); COMAR 26.08.02.02-1

### 13) Submerged Aquatic Vegetation – Special Conditions 25, 26

Statement of Necessity: SAV are a critical habitat for many aquatic species. Limitations on loss will sustain habitat for a variety of aquatic species, including anadromous fish and threatened or endangered species. Water quality regulations state minimum thresholds for SAV in tidal waterways. In addition to direct loss, turbidity created by construction or ongoing operation must be limited for support of aquatic life and meet water quality standards. Unmitigated loss of SAV may result in failure to meet SAV extents which are part of water quality standards, as well as designated use class for support of estuarine and marine aquatic life and shellfish harvesting.

Citations: COMAR 26.08.02.03-3C(9); COMAR 26.08.02.03B(1)(b); 26.08.02.03B(2)

### 14) Marsh Establishment, Maintenance, and Mitigation - Special Conditions 22, 23, 24

Statement of Necessity for Condition: Tidal wetlands provide essential habitat, water quality, food, and movement corridors for wildlife, and support of estuarine and marine aquatic life and shellfish harvesting. Successful establishment is necessary to prevent discharges which interfere with designated uses, including growth and propagation of fish, other aquatic life, and wildlife through loss of stream channel habitat and wetlands. Required establishment, re-establishment, or enhancement and loss limits will maintain the designated use.

Citations: COMAR 26.08.02.02B(3); COMAR 26.08.02.03B(3) and B(4); COMAR 26.24.

### 15) Adaptive Management and Habitat Improvement – Special Condition 24

Statement of Necessity for Condition: Tidal and nontidal wetlands, mudflats, and shallow water habitat provide essential habitat, water quality, food, and movement corridors for wildlife, and support of estuarine and marine aquatic life and shellfish harvesting. Successful establishment is necessary to prevent discharges which interfere with designated uses, including growth and propagation of fish, other aquatic life, and wildlife through loss of stream channel habitat and wetlands. Required establishment, re-establishment, or enhancement and loss limits will maintain the designated use. Adaptive plans allow for adjustments to ensure that habitat and the associated designated uses are maintained.

Citations: COMAR 26.08.02.02B(1)-(3); COMAR 26.08.02.03B(1)- B(4); COMAR 26.24; COMAR 26.23

### 16) Use of Borrow Material – Special Condition 27

Statement of Necessity for Condition: Material must be removed and placed in a manner which does not increase turbidity or result in release of toxic materials above numerical standards. Limits or prohibitions are necessary to protect all designated uses from effects of toxic materials. Material used in island enhancement, expansion, and creation of habitat must have certain soil characteristics for stability and plant growth in order to ensure designated uses for support of designated uses for growth and propagation of fish, other aquatic life, and wildlife are met.

Citations: COMAR 26.08.02.03-1; COMAR 26.08.02.02; COMAR 26.08.02.03B(1)(b); COMAR 26.08.02.03B(2); COMAR 26.24; COMAR 26.23; COMAR 26.17.04

**CERTIFICATION APPROVED**



---

D. Lee Currey, Director  
Water and Science Administration

**Apr 13, 2022**

---

Date

Tracking Number: 202160895  
Agency Interest Number: 163561

Effective Date: April 13, 2022

Enclosure: Plan Sheets dated April 11, 2022

cc: WSA Inspection & Compliance Program  
US Army Corps of Engineers

# Barren Island Vicinity Map

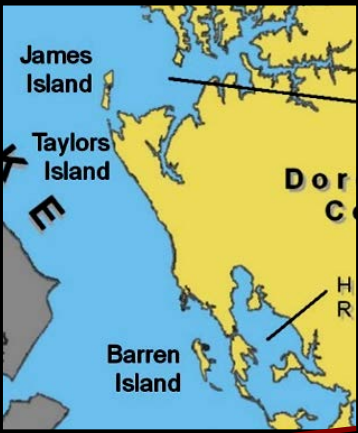
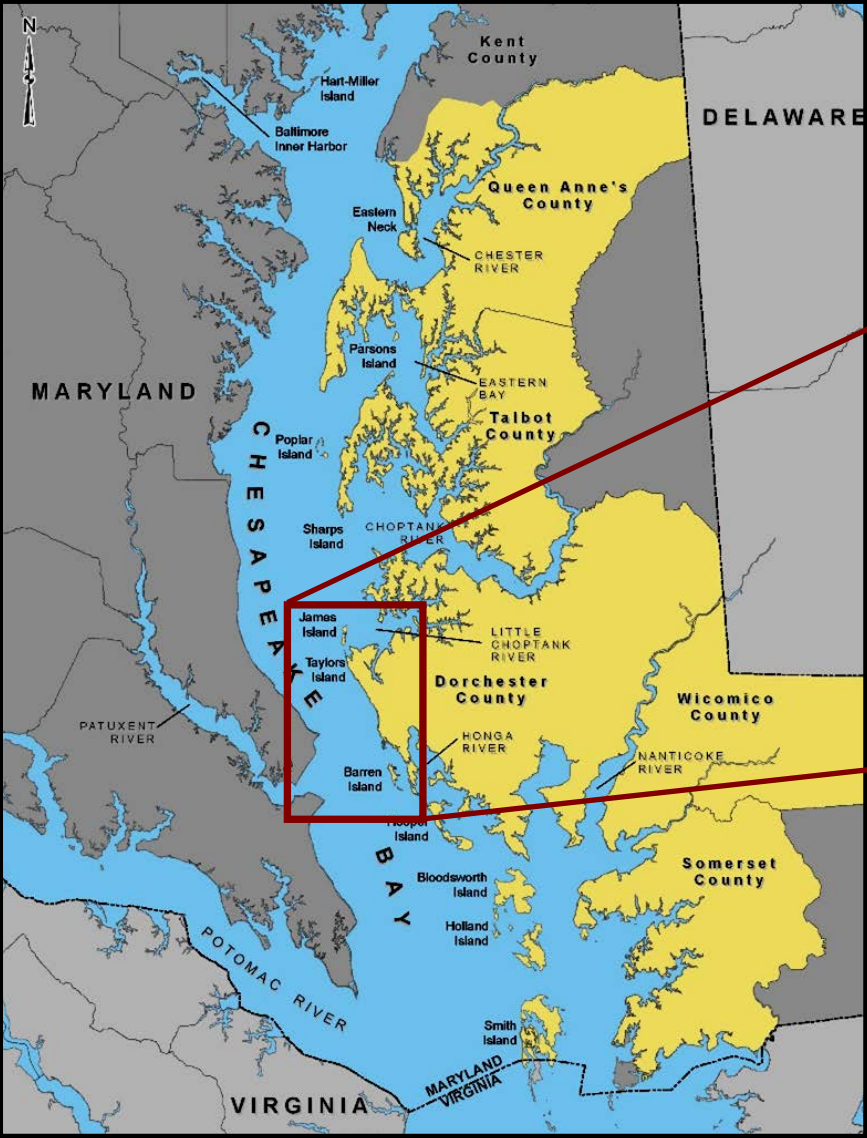

21-WQC-0331  
202160895  
AI-163561  
4/11/2022  
Sheet 1 of 12

Barren Island is located directly to the west of Upper Hoopers Island in Dorchester County, Maryland

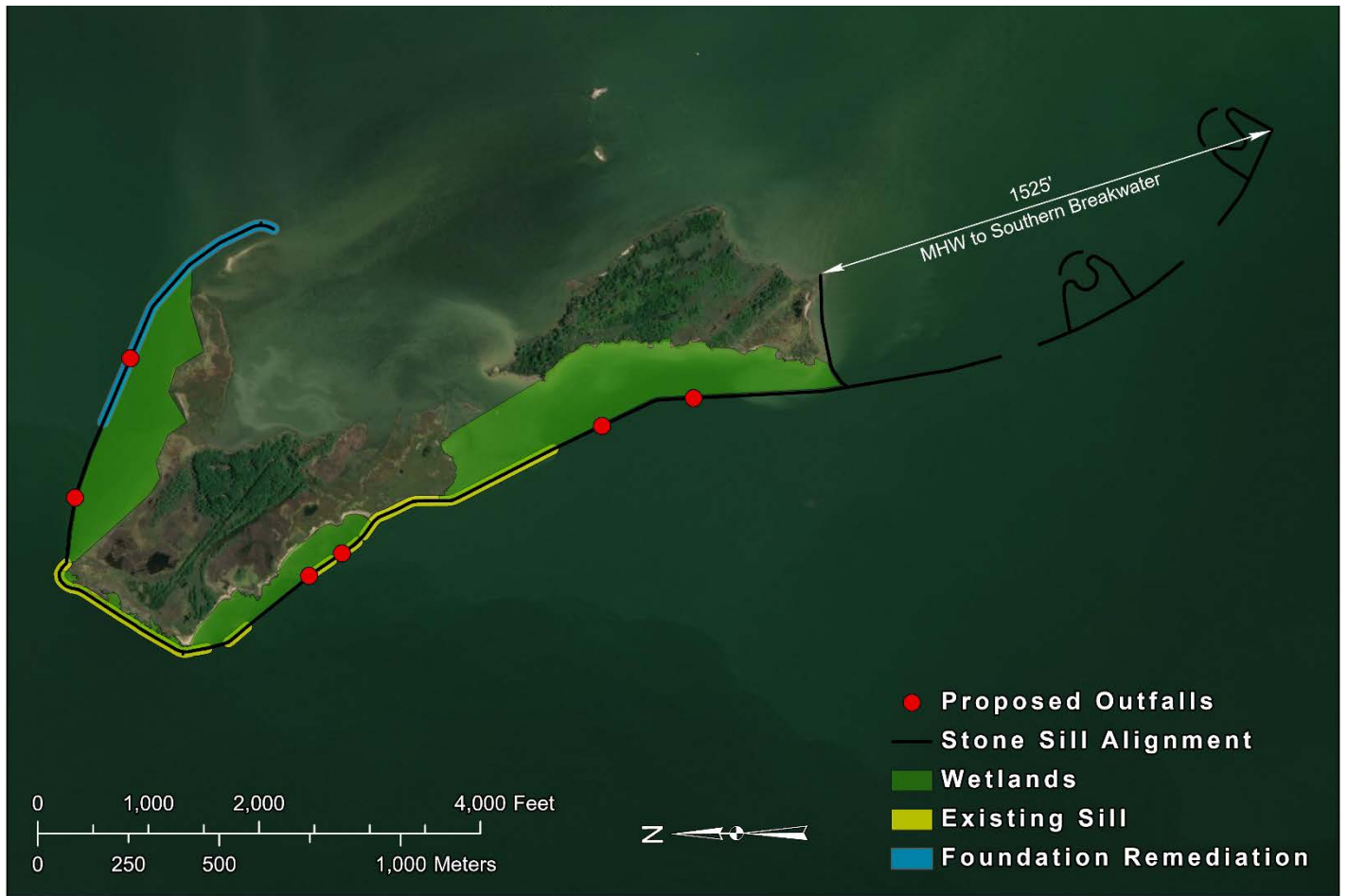

### Barren Island Restoration Plan

The restoration effort at Barren will be comprised of the following components: modification or installation of 13,023 ft of protective stone sill, installation of 4,620 ft of southern breakwater, installation of 2 bird islands (8.5 acres total), and installation of ~83 acres of wetlands. Final design of the wetlands will depend on current conditions at construction. Currently, six outfall locations are planned to allow for tidal exchange.





**Barren Island Natural Resource Map**

Barren Island is located approximately 1 mile west of Upper Hoopers Island. Once constructed, the protective stone sills and southern breakwater will provide not only shoreline protection for Barren Island and Upper Hoopers Island, but protection of the extensive submerged aquatic vegetation (SAV) bed (over 1,000 acres) to the east of Barren Island.



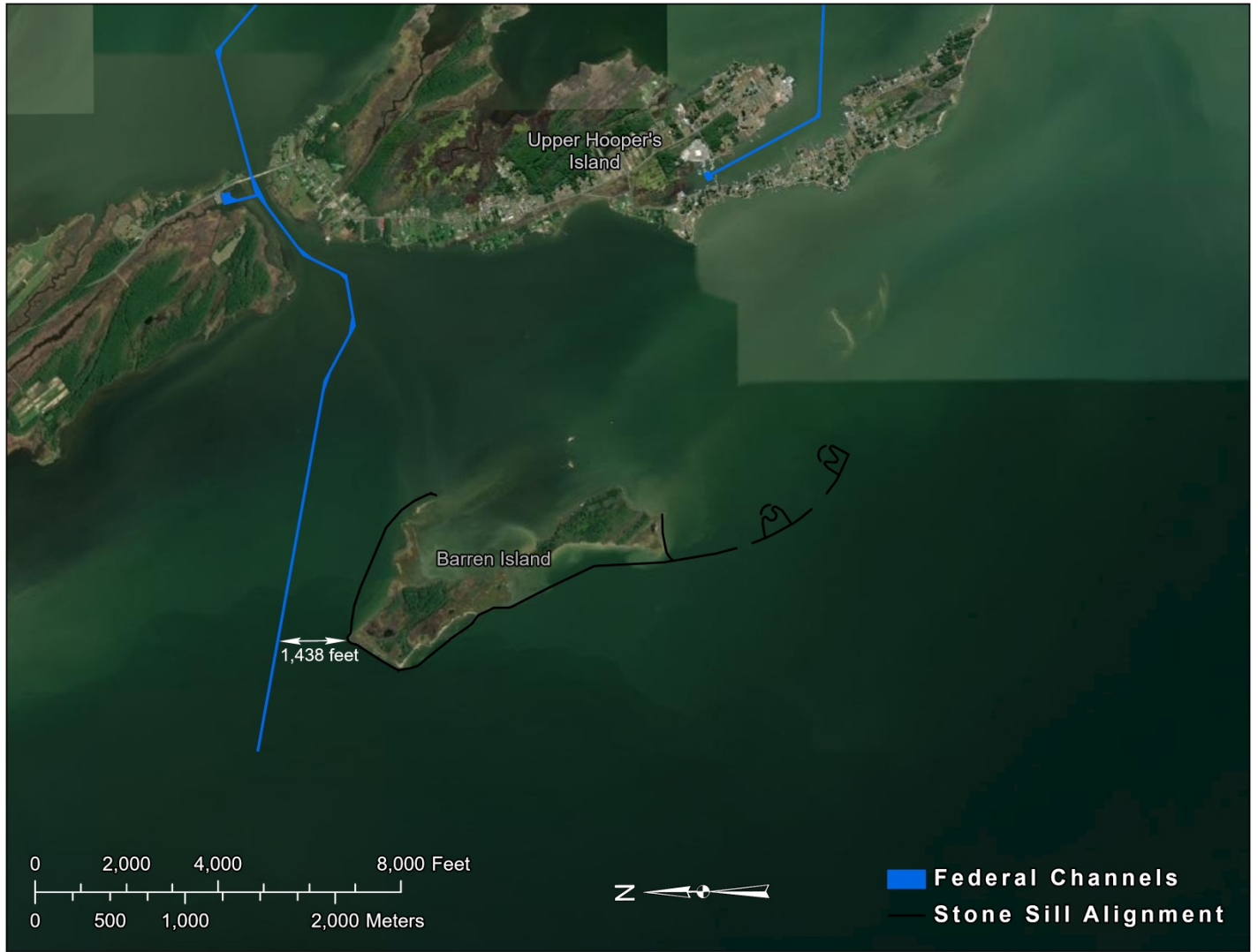

**Barren Island and Historic and Navigation Channel Location**

Barren Island is located approximately a quarter mile south of the Honga River channel, which is the only channel in the immediate vicinity.

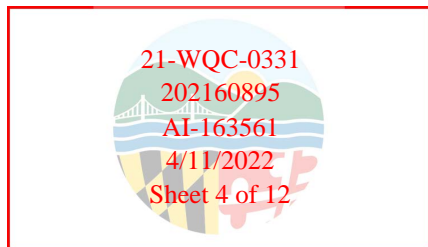



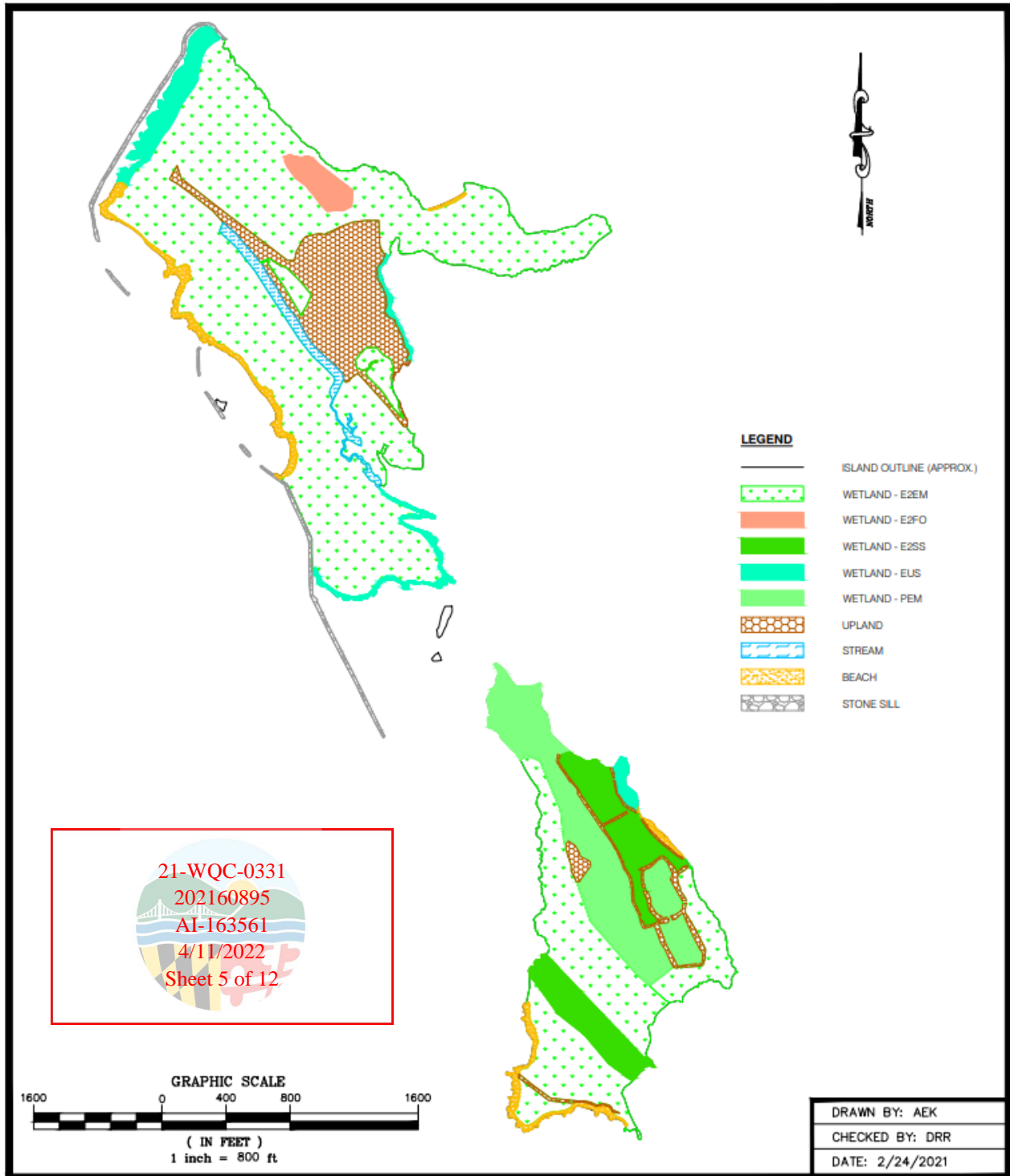

### Page 5 – Barren Island Existing Resources

Of the 138 acres remaining of Barren Island, over 80 acres of wetland habitat is present. Once the restoration project is complete, approximately 83 acres of wetland will be added. The above resource map was created using 2020 LiDAR data and the 2020 wetland delineation study.

0.33' —————	MEAN HIGHER HIGH WATER (MHHW)
0.16' —————	MEAN HIGH WATER (MHW)
0.00' —————	NORTH AMERICAN VERTICAL DATUM OF 1988 (NAVD88)
-0.45' —————	MEAN TIDE LEVEL (MTL)
-1.06' —————	MEAN LOW WATER (MLW)
-1.22' —————	MEAN LOWER LOW WATER (MLLW)

TIDAL DATUMS AT BARREN ISLAND, MD FOR THE  
1983–2001 TIDAL EPOCH\*

NOT TO SCALE

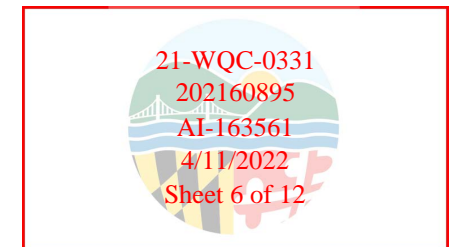

1

2

3

4

5

### NORTHEAST SILL

FROM STA. 125+20.2 TO 138+25.08

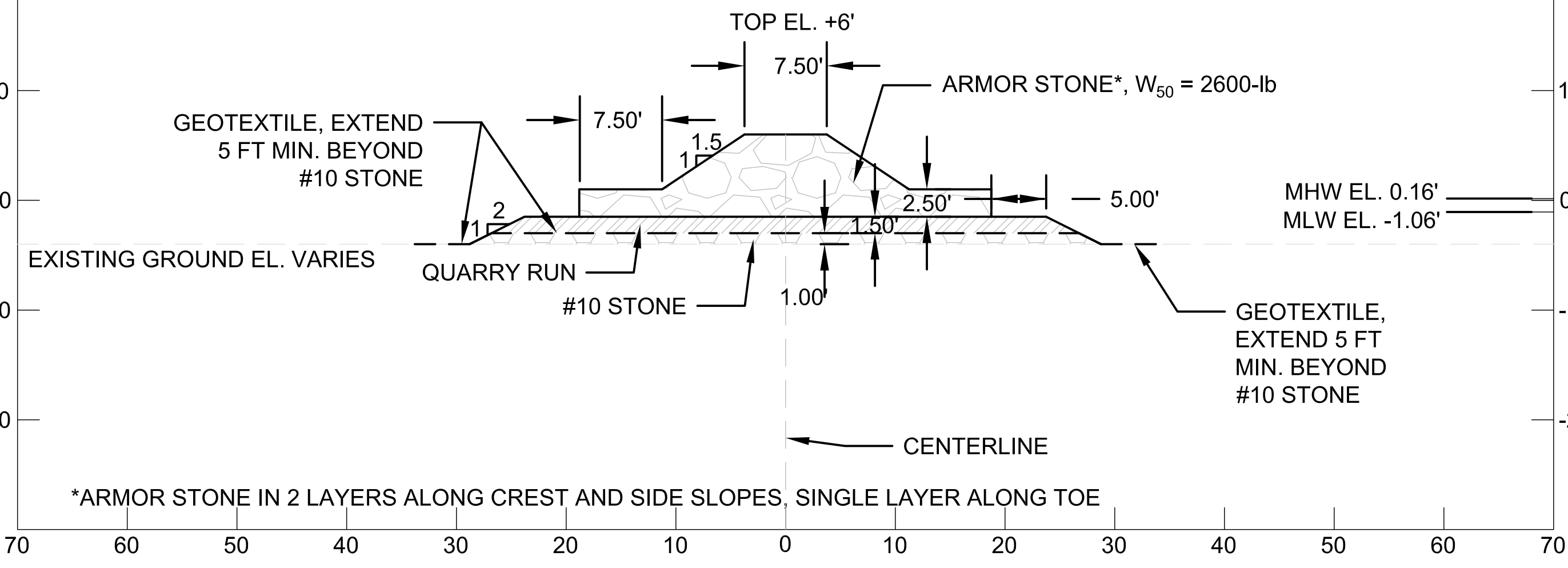

### MODIFICATION OF EXISTING SILL

FROM STA. 200+00 TO 218+03, 218+97 TO 221+20, 228+90 TO 231+10, 232+90 TO 234+03, AND 234+47 TO 254+00

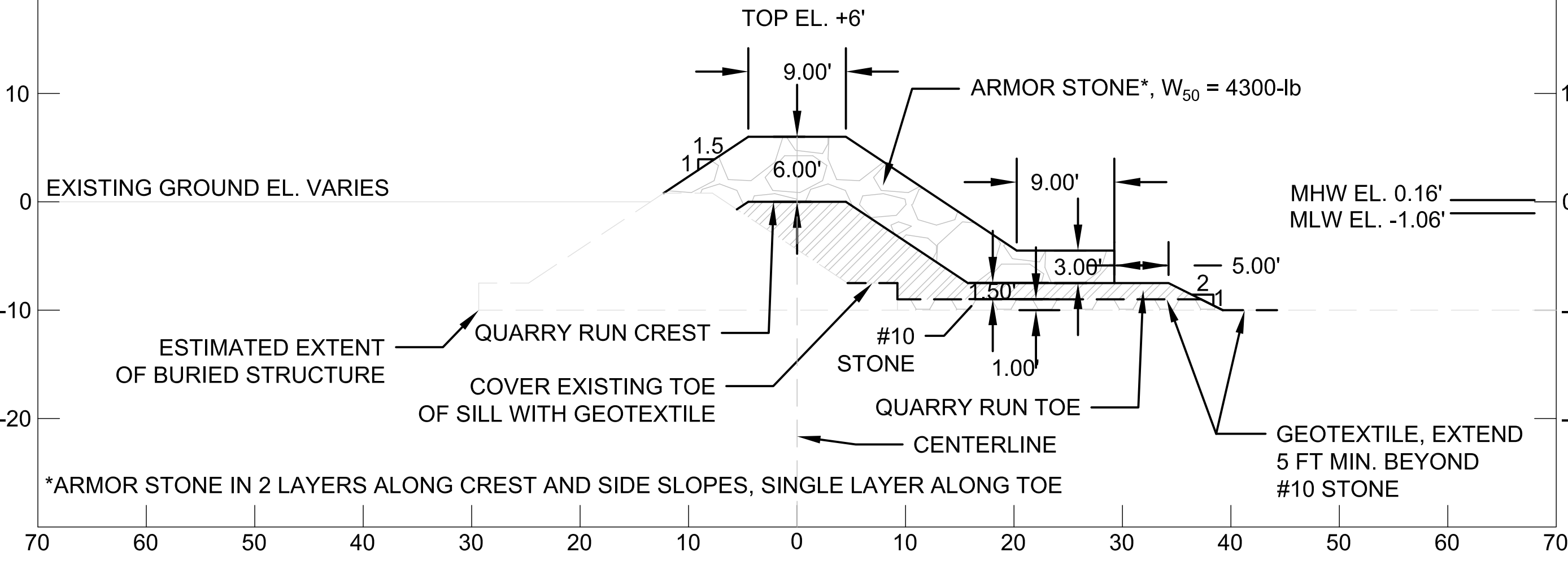

### EXISTING SILL GAP/SOUTHWEST/SOUTHEAST SILL

FROM STA. 221+20 TO 228+90, 231+10 TO 232+90, 254+00 TO 255+69.47, STA. 300+00 TO 323+49.66, AND STA. 402+50 TO 409+66.74

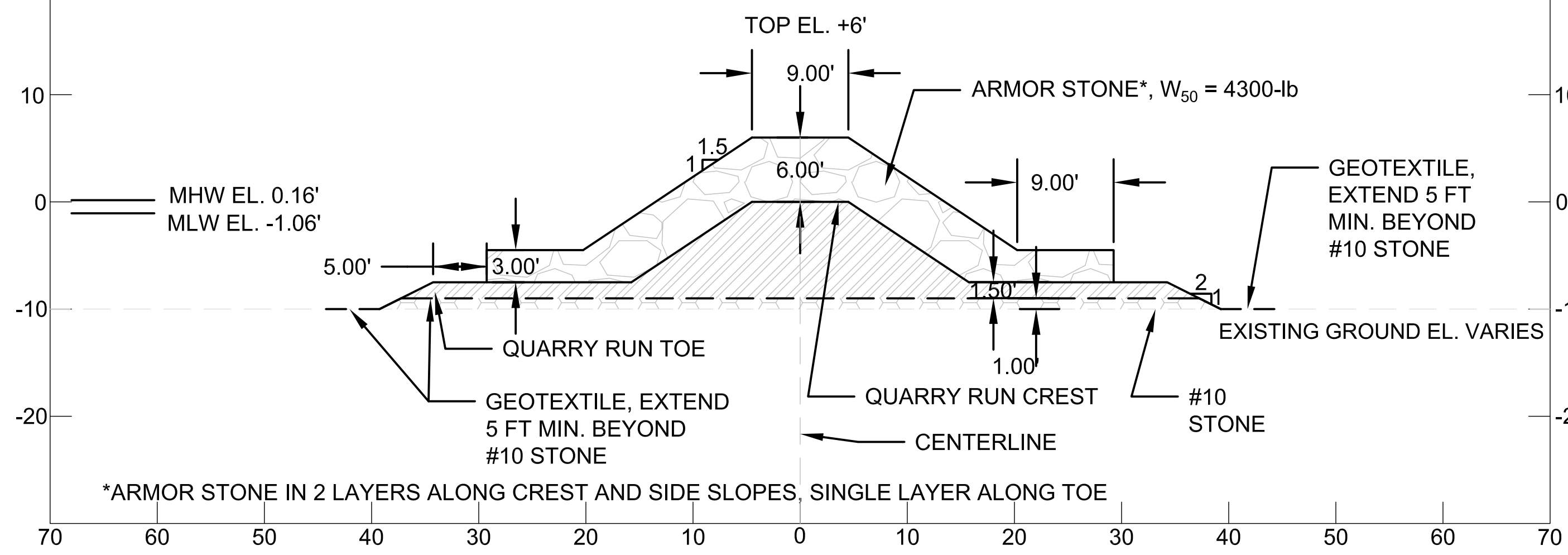

### BREAKWATER

FROM STA. 500+00 TO 513+05.89, 601+00 TO 614+00, AND 701+00 TO 712+63.77

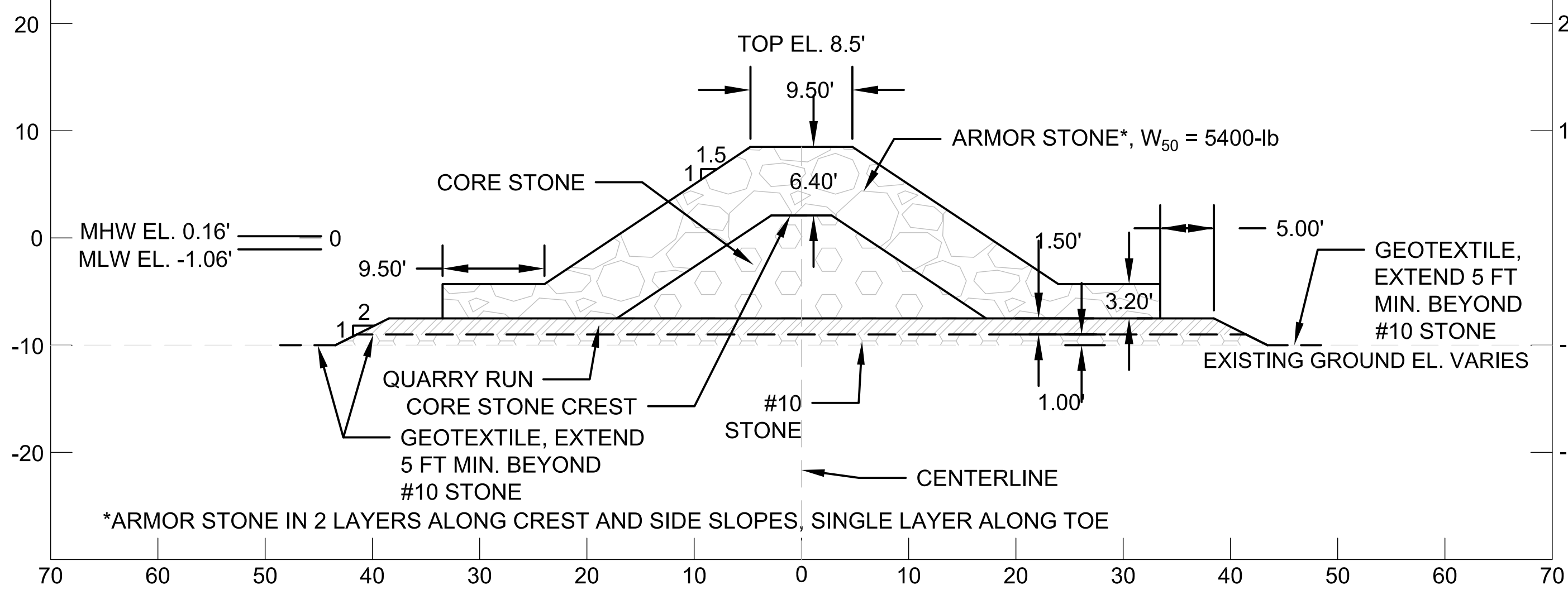

DATE	DESCRIPTION	APPR.	MARK

DESIGNED BY:	DATE:	SUBMITTED BY:	DATE:
DWN BY:			

MID-CHESAPEAKE BAY ISLAND ECOSYSTEM RESTORATION PROJECT  
 BARREN ISLAND RESTORATION PHASE I STONE STRUCTURES  
 TYPICAL SECTIONS

SHEET IDENTIFICATION  
**C301**

- NOTES:
1. ALL ELEVATIONS SHOWN ARE IN VERTICAL DATUM NAVD88.
  2. W50 = NOMINAL MEAN SIZE OF THE ARMOR STONE.
  3. REFER TO DIV 31 05 19 FOR GEOTEXTILE SPECIFICATIONS

21-WQC-0331  
 202160895  
 AI-163561  
 4/11/2022  
 Sheet 7 of 12

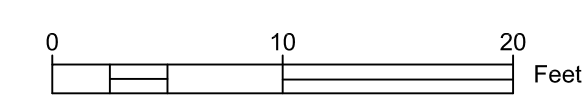



# TYPICAL SECTION THROUGH WETLAND CELL CONCEPT

SCALE REPRESENTS 80/20 RATIO OF LOW MARSH TO HIGH MARSH

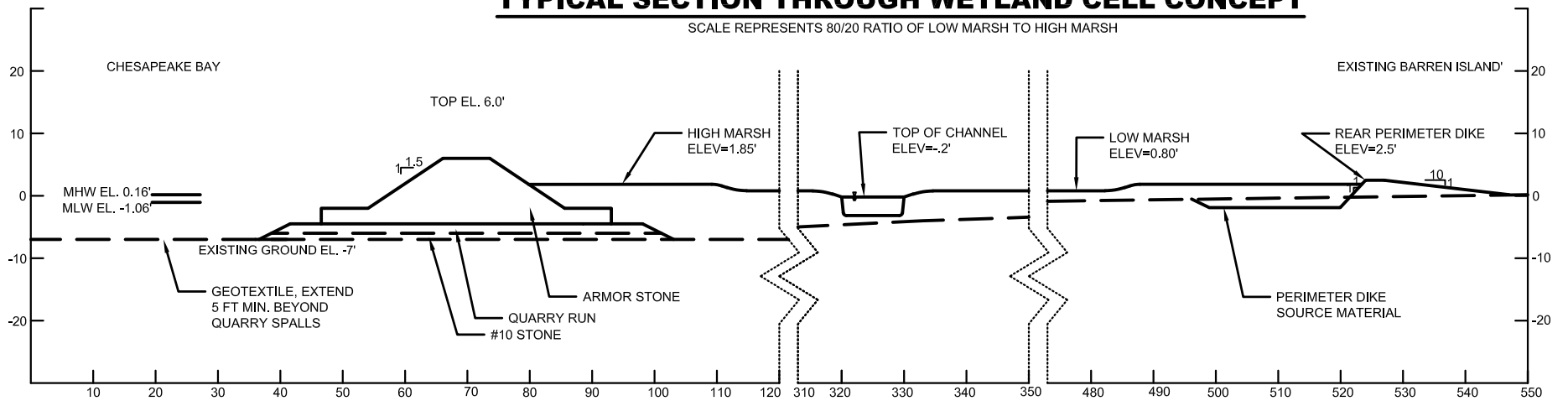

21-WQC-0331  
202160895  
AI-163561  
4/11/2022  
Sheet 9 of 12





### Barren Island Impacts Table

Work Proposed	Overall Length	Average Width	Average Depth	Vol. of Dredged or Fill Material	Total Area Impacted	Max Channelward Distance	Habitat Creation <sup>1</sup>	
All new work	Ft.	Ft.	Ft.	CY	Sq. Ft.	Ft.	Acres	
<b>Breakwater and Sill Features</b>								
Sills (NE, NW, and SW)	~13,023	70	-	-	~911,610	-	-	
Southern Breakwater (including stone structures for the bird islands)	~4,620	90	-	-	~415,800	1,525	-	
<b>Dredging Activities (Foundation Work)</b>								
Removal of unsuitable foundation material identified under the NE sill	~2,500	60	7	~52,500	~150,000	-	-	
<b>Fill Activities (Foundation Work, Bird Islands, and Wetlands)</b>								
<b>Foundation Work</b>								
Replacement of unsuitable foundation material identified under the NE sill with sand from an allowable sand source	~2,500	60	7	~52,500	~150,000	-	-	
<b>Bird Island Impacts</b>								
Lot Fill (2 bird island)	-	-	-	~154,000	~370,260	-	Remote Bird Islands	8.5
<b>Wetland Impacts (current wetland impacts calculated from the overlap of the proposed wetlands and current wetlands identified in the wetland delineation report and LiDAR data)</b>								
Lot Fill (3 wetlands)	-	-	-	~429,000	~3,606,768	-	Wetlands	82.8
-	-	-	-	-	-	-	High Marsh	15.56 - 38.9
-	-	-	-	-	-	-	Low Marsh	62.24 - 38.9
-	-	-	-	-	-	-	Mud Flats	~5
Total wetland impacts from lot fill (~1.41 acres)	-	-	-	-	~61,420	-	-	
~27.9-Acre NE Wetland (.17-acre impact)	-	-	-	-	7,405	-	-	
~12.4-Acre NW Wetland (.79-acre impact)	-	-	-	-	34,412	-	-	
~42.5-Acre SW Wetland (.45-acre impact)	-	-	-	-	19,602	-	-	
Total open water impacts from lot fill (~81.39 acres)	-	-	-	-	~3,545,348	-	-	

1 - Totals wetland types represent wetland ratios of 80/20 to 50/50 low marsh to high marsh

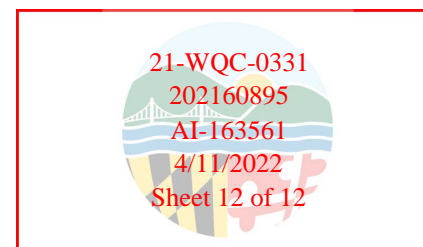









# 21-WQC-0331 Barren Island

Final Audit Report

2022-04-13

Created:	2022-04-13
By:	Heather Nelson for (hnelson@maryland.gov)
Status:	Signed
Transaction ID:	CBJCHBCAABAATd2Vj7tsMmjrerz91klr8kDPzy3UqTHv

## "21-WQC-0331 Barren Island" History

-  Document created by Heather Nelson for (hnelson@maryland.gov)  
2022-04-13 - 6:38:37 PM GMT
-  Document e-signed by Heather Nelson for (hnelson@maryland.gov)  
Signature Date: 2022-04-13 - 6:40:45 PM GMT - Time Source: server
-  Document emailed to Matthew C. Rowe (mde.wsaepermits@maryland.gov) for signature  
2022-04-13 - 6:40:47 PM GMT
-  Email viewed by Matthew C. Rowe (mde.wsaepermits@maryland.gov)  
2022-04-13 - 6:40:53 PM GMT
-  Document e-signed by Matthew C. Rowe (mde.wsaepermits@maryland.gov)  
Signature Date: 2022-04-13 - 8:44:31 PM GMT - Time Source: server
-  Agreement completed.  
2022-04-13 - 8:44:31 PM GMT