



Maryland
Department of
the Environment

Larry Hogan, Governor
Boyd K. Rutherford, Lt. Governor

Horacio Tablada, Secretary
Suzanne E. Dorsey, Deputy Secretary

July 12, 2022

Richard and Mary Rathmann
c/o Sean William Companies LLC
P.O. Box 1466
Annapolis, MD 21404

Via email: sean@sean-william.com
rgrathmann@gmail.com

Re: Agency Interest Number: 153686
Tracking Number: 202260932
Tidal Authorization Number: 22-WQC-0016

Dear Richard Rathmann:

Your project did not qualify for approval under the Maryland State Programmatic General Permit (MDSPGP); therefore a separate review and issuance of the federal permit will be required by the U.S. Army Corps of Engineers. The federal permit is not attached.

Additionally, your project required a Wetlands License to be approved and issued by the Maryland Board of Public Works (BPW). The Wetlands License will be sent to you by BPW's Wetlands Administrator.

A project that does not qualify for approval under the MDSPGP requires an individual Water Quality Certification (WQC) to be issued by the Maryland Department of the Environment, which is attached. Please take a moment to read and review your WQC to ensure that you understand the limits of the authorized work and all of the general and special conditions.

You should not begin any work until you have obtained all necessary State, local, and federal authorizations. Please contact Heather Hepburn at heather.hepburn1@maryland.gov or 410-537-3789 with any questions.

Sincerely,

A handwritten signature in black ink that reads "Tammy K. Roberson".

Tammy K. Roberson, Chief
Wetlands & Waterways Program
Tidal Wetlands Division



STATE OF MARYLAND
DEPARTMENT OF THE ENVIRONMENT
WATER AND SCIENCE ADMINISTRATION
WATER QUALITY CERTIFICATION



22-WQC-0016

EFFECTIVE DATE: **July 12, 2022**
CERTIFICATION HOLDER: **Richard and Mary Rathmann**
ADDRESS: **5 Murray Ave, Apt A**
Annapolis, MD 21401
PROJECT LOCATION: **523 Horn Point Dr**
Annapolis, MD 21403

UNDER AUTHORITY OF SECTION 401 OF THE FEDERAL WATER POLLUTION CONTROL ACT AND ITS AMENDMENTS AND IN ACCORDANCE WITH § 9-313 THROUGH § 9-323, INCLUSIVE, OF THE ENVIRONMENT ARTICLE, ANNOTATED CODE OF MARYLAND, THE MARYLAND DEPARTMENT OF THE ENVIRONMENT, WATER AND SCIENCE ADMINISTRATION HAS DETERMINED THAT THE REGULATED ACTIVITIES DESCRIBED IN THE REQUEST FOR CERTIFICATION FOR THE PROPOSED LIVING SHORELINE AND AS DESCRIBED IN THE ATTACHED PLAN SHEETS DATED FEBRUARY 11, 2022 AND ANY SUBSEQUENT MODIFICATIONS APPROVED BY THE DEPARTMENT WILL NOT VIOLATE MARYLAND'S WATER QUALITY STANDARDS, IF CONDUCTED IN ACCORDANCE WITH THE CONDITIONS OF THIS CERTIFICATION.

THIS CERTIFICATION DOES NOT RELIEVE THE APPLICANT OF RESPONSIBILITY FOR OBTAINING ANY OTHER APPROVALS, LICENSES, OR PERMITS IN ACCORDANCE WITH FEDERAL, STATE, OR LOCAL REQUIREMENTS AND DOES NOT AUTHORIZE COMMENCEMENT OF THE PROPOSED PROJECT. A COPY OF THIS REQUIRED CERTIFICATION HAS BEEN SENT TO THE CORPS OF ENGINEERS. THE CERTIFICATION HOLDER SHALL COMPLY WITH THE CONDITIONS LISTED BELOW.

PROJECT DESCRIPTION

1. To fill, grade, and plant with approximately 2,780 square feet of marsh vegetation along 75 feet of bulkheaded shoreline with 100 cubic yards of sand using a 12-foot wide by 112-foot long series of low profile stone sills, with one 15-foot wide vent, all within a maximum of 85 feet channelward of the mean high water line at an existing bulkhead;
2. Construct a 166-foot long by 6-foot wide pier with a 13.5-foot by 14-foot irregularly shaped platform, a 14-foot long by 3-foot wide finger pier, a 12-foot by 10-foot boat lift with associated piles, a 10-foot by 6-foot wide side mount boat lift, and three mooring piles, all extending a maximum of 180 feet channelward of the existing bulkhead; and
3. Construct 75 feet of stone revetment within a maximum of 6 feet channelward of the bulkhead.

GENERAL CONDITIONS

1. This Certification does not obviate the need to obtain required authorizations or approvals from other State, federal or local agencies as required by law.
2. All additional authorizations or approvals, including self-certifying General Permits issued by the Department, shall be obtained and all conditions shall be completed in compliance with such authorizations.
3. The proposed project shall be constructed in accordance with the approved final plan by the Department, or, if Department approval is not required, the plan approved by the U.S. Army Corps of Engineers; and its approved revisions.
4. All fill and construction materials not used in the project shall be removed and disposed of in a manner which will prevent their entry into waters of this State.
5. This Certification does not authorize any injury to private property, any invasion of rights, or any infringement of federal, state, or local laws or regulations.
6. Authorized representatives of the Department shall be provided access to the site of authorized activities during normal business hours to conduct inspections and evaluations of the operations and records necessary to assure compliance with this Certification.
7. Authorized work under this Certification shall be performed in accordance with the required Soil Erosion and Sediment Control Plan as approved by the Maryland Department of the Environment.
8. No stockpiles of any material shall be placed in Waters of the U.S. or state or private tidal wetlands.
9. Temporary construction trailers or structures, staging areas and stockpiles shall not be located within tidal wetlands, nontidal wetlands, nontidal wetlands buffers, or the 100-year floodplain unless specifically included on the Approved Plan.
10. This Certification is valid for the project identified herein and the associated U.S. Army Corps of Engineers authorization 201661328 until such time that it expires or is not administratively extended.

SPECIAL CONDITIONS

1. All water quality-related performance standards and conditions required by the Department in any state issued authorization for activities in tidal wetlands, nontidal waterways, their 100-year floodplains, nontidal wetland buffers, or nontidal wetland expanded buffers to ensure that any discharges will not result in a failure to comply with water quality standards in COMAR 26.08.02. or other water quality requirements of state law or regulation shall be met.
2. All Critical Area requirements shall be followed and all necessary authorizations from the Critical Area Commission (“Commission”) shall be obtained. This Certificate does not constitute authorization for disturbance in the 100-foot Critical Area Buffer. “Disturbance” in the Buffer means clearing, grading, construction activities, or removal of any size of tree or vegetation. Any anticipated Buffer disturbance requires prior written approval, before commencement of land disturbing activity, from local jurisdiction in the form of a Buffer Management Plan.

3. All work performed under this Water Quality Certificate shall be conducted by a marine contractor licensed by the Marine Contractors Licensing Board (MCLB) in accordance with Title 17 of the Environment Article of Annotated Code of Maryland. Licensing by MCLB shall occur prior to the beginning of construction activities. A list of licensed marine contractors may be obtained by contacting the MCLB at 410-537- 3249, by e-mail at MDE.MCLB@maryland.gov or by accessing the Maryland Department of the Environment, Environmental Boards webpage.
4. The issuance of this Certificate is not a validation or authorization by the Department for any of the existing structures depicted on the plan sheets on the subject property that is not part of the authorized work description, nor does it relieve the Certificate Holder of the obligation to resolve any existing noncompliant structures and activities within tidal wetlands.
5. The Certificate Holder shall follow the requirements of the marsh maintenance plan as required by Wetlands License 16-0764(R2).
6. The Certificate Holder shall construct the marsh establishment area in accordance with the following conditions:
 - a. Certificate Holder shall use clean substrate fill material, no more than 10% of which shall pass through a standard number 100 sieve.
 - b. The marsh establishment area shall be planted within one year following completion of the filling operation.
 - c. The marsh establishment project shall be maintained as a wetland, with non-nuisance species' aerial coverage of at least 85% for three consecutive years. If 85% coverage is not attained, the reasons for failure shall be determined, corrective measures shall be taken, and the area shall be replanted.
 - d. If the fill is graded hydraulically, Certificate Holder shall use a turbidity curtain around the perimeter of the instream work.
 - e. If the existing bank is to be cleared or graded, Certificate Holder shall obtain any required approvals of an erosion and sediment control plan from the applicable sediment and erosion control agency.
 - i. The Certificate Holder shall perform all work under and in accordance with an approved Soil Erosion and Sediment Control Plan from the applicable sediment and erosion control agency; and
 - ii. The Certificate Holder shall perform all work under and in accordance with the Critical Area requirements of the local jurisdiction in the form of an approved Buffer Management Plan.
7. The Certificate Holder shall design and construct the stone revetment to prevent the loss of fill material to waters of the State of Maryland.
8. The Certificate Holder shall not use asphalt rubble in the revetment. Filter cloth shall be placed between the riprap and the soil. Prior to emplacement of the revetment, all rebar is to be cut off flush with the concrete. After emplacement of the revetment, any rebar exposed as a result of the concrete breaking during the emplacement is to be cut flush with the concrete. Except for the larger material placed along the leading edge of the revetment, the concrete shall be broken prior to emplacement so that random sized interlocking pieces are formed.

CITATIONS AND STATEMENTS OF NECESSITY

1) General Authorities; Need for Other Permits

a) General Conditions 1, 2, 10; Special Condition 2

Statement of Necessity for Condition: The condition is necessary to ensure that water quality standards are met under unique circumstances for discharges which may otherwise qualify under the certified Nationwide Permits and to maintain designated uses of waters.

Citation: Federal and state laws that authorize this condition include but are not limited to: 33 U.S.C. § 1341(a), (b), & (d); 33 U.S.C. § 1251(b); 33 U.S.C. § 1370; Md. Ann. Code, Env. Article, Title 1, Subtitles 3 and 4; Md. Ann. Code, Env. Article, Title 5, Subtitles 5 and 9; Md. Ann. Code, Env. Article, Title 9, Subtitle 3; Md. Ann. Code, Env. Article, Title 16; COMAR 26.08; COMAR 26.08.02.10G(3); COMAR 26.23.02.06; COMAR 26.17.01; COMAR 26.23; COMAR 26.24

b) General Condition 3

Statement of Necessity for Condition: The condition is necessary to ensure that water quality standards are met under unique circumstances for discharges which may otherwise qualify under the terms of the federal authorization and to maintain designated uses of waters. The Corps of Engineers authorization and plans include details about amount and location of discharges, as well as other conditions for reducing adverse effects to water quality, which ultimately supports maintaining designated uses. The Certification conditions and decision are based upon based on the details of the Corps of Engineers authorization and plans.

Citation: COMAR 26.08.02.01E(2)

c) General Condition 5

Statement of Necessity for Condition: The condition is necessary to clarify the scope of this certification to ensure compliance with water quality regulations, without limiting restrictions through other requirements.

Citation: Federal and state laws that authorize this condition include but are not limited to: 33 U.S.C. § 1341(a), (b), & (d); 33 U.S.C. § 1251(b); 33 U.S.C. § 1370; Md. Ann. Code, Env. Article, Title 1, Subtitles 3 and 4; Md. Ann. Code, Env. Article, Title 5, Subtitles 5 and 9; Md. Ann. Code, Env. Article, Title 9, Subtitle 3; Md. Ann. Code, Env. Article, Title 16; COMAR 26.08, COMAR 26.08.02.10E; COMAR 26.23.02.06; COMAR 26.17.04; COMAR 26.23; COMAR 26.24

2) Unauthorized or Incidental Discharges - General Conditions 4, 8, 9; Special Conditions 5, 6, 7, 8

Statement of Necessity for Condition: Fill or construction material within or adjacent to regulated resources may cause discharges resulting in turbidity in excess of water quality standards and interfere with designated uses of growth and propagation of fish, other aquatic life, wildlife; and other designated uses; and fail to meet general water quality criteria that waters not be polluted by substances in amounts sufficient to be unsightly or create a nuisance.

Citation: 26.08.02.03B(1)-B(2); COMAR 26.23; COMAR 26.24; COMAR 26.17.04

3) Inspections and Compliance - General Condition 6

Statement of Necessity for Condition: Conditions of certification involve precise actions to comply with water quality standards. Site inspection may be necessary to ensure that limits, methods, and other requirements are met to ensure that water quality standards are met and designated uses are maintained. These conditions are necessary to ensure that the activity was conducted and project completed according to terms of the authorization/certification, while allowing for review of in-field modifications which may have resulted in discharges to ensure that water quality standards were met. Designated uses include support of estuarine and marine aquatic life and shellfish harvesting and for growth and propagation of fish, other aquatic life, and wildlife

Citation: Federal and state laws that authorize this condition include but are not limited to: 33 U.S.C. § 1341(a), (b), & (d); 33 U.S.C. § 1251(b); 33 U.S.C. § 1370; Md. Ann. Code, Env. Article, Title 1, Subtitles 3 and 4; Md. Ann. Code, Env. Article, Title 5, Subtitles 5 and 9; Md. Ann. Code, Env. Article, Title 9, Subtitle 3; Md. Ann. Code, Env. Article, Title 16; COMAR 26.08; COMAR 26.08.02.03B(1)(b); COMAR 26.08.02.03B(2); COMAR 26.23.02.06; COMAR 26.23; COMAR 26.24; COMAR 26.17.04

5) Performance Standards for Water Quality - Special Condition 1

Statement of Necessity for Condition: This condition is necessary to ensure that discharges will be conducted in a manner which does not violate water quality criteria nor interfere with designated uses.

Citation: COMAR 26.08.02.03B(1)(b); 26.08.02.03B(2);

6) Licensed Marine Contractor - Special Condition 3

Statement of Necessity: Expertise for conducting certain activities is required to ensure that there is no violation of water quality standards nor interference with designated uses. This condition is necessary to ensure that discharges will be conducted in a manner which does not violate water quality criteria nor interfere with designated uses.

Citation: COMAR 26.08.02.02B(2)- B(4); COMAR 26.08 02.03B(2)(d) – (e); COMAR 26.08.02.03B(1)(b); 26.08.02.03B(2); COMAR 23.02.04.04

7) Marsh Establishment and Maintenance - Special Conditions 5, 6

Statement of Necessity for Condition: Tidal wetlands provide essential habitat, water quality, food, and movement corridors for wildlife, and support of estuarine and marine aquatic life and shellfish harvesting. Successful establishment is necessary to prevent discharges which interfere with designated uses, including growth and propagation of fish, other aquatic life, and wildlife through loss of stream channel habitat and wetlands. Required establishment, re-establishment, or enhancement and loss limits will maintain the designated use.

Citations: COMAR 26.08.02.02B(3); COMAR 26.08.02.03B(3) and B(4); COMAR 26.24.

CERTIFICATION APPROVED

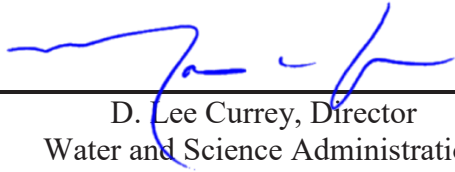

D. Lee Currey, Director
Water and Science Administration

7/13/2022

Date

Tracking Number: 202260932
Agency Interest Number: 153686

Effective Date: July 12, 2022

Enclosure: Plan Sheets date February 11, 2022

cc: WSA Inspection & Compliance Program
Army Corps of Engineers

VICINITY MAP AND PROJECT LOCATION

SCALES FOR MAPS AS SHOWN

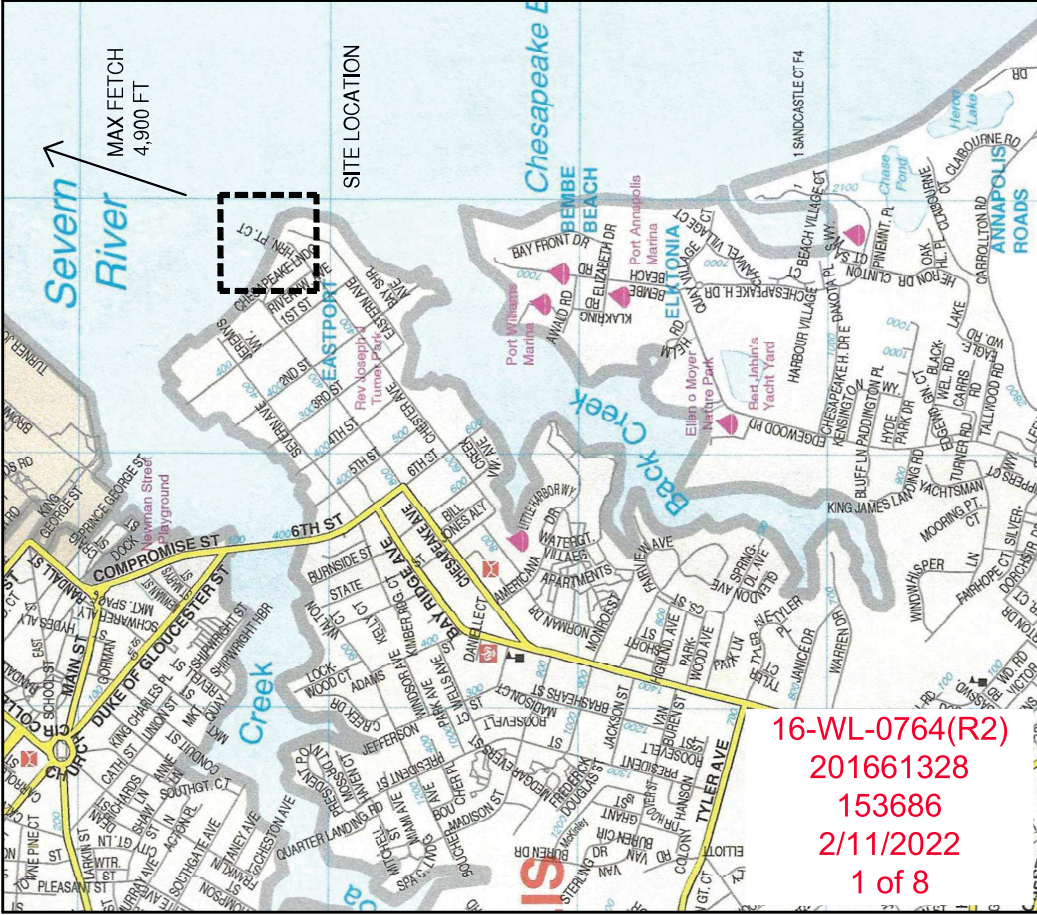

16-WL-0764(R2)
201661328
153686
2/11/2022
1 of 8



AERIAL MAP | ANNE ARUNDEL COUNTY | COUNTY PROVIDED GIS

VICINITY MAP | ANNE ARUNDEL COUNTY | MAP 53 | PAGE 43 | ADC MAP | SCALE 1" = 2000'

PROPOSED PROJECT:

- (1) CONSTRUCT 6" X 166" PIER WITH 14" X 135" "L" HEAD
- (2) 3 MOORING PILES WITH 3" X 143" FINGER PIER
- (3) CONSTRUCT 2 BOAT LIFTS, LIFT (1) LIFT BEAMS SPACED 10'-0" APART
- (4) LIFT (2) TO BE ANCHORED TO PIER PILES AND CANTILEVERED
- (5) INSTALLATION OF LIVING SHORELINE WITH SILLS
- (6) REPLACE IN-KIND EXISTING FALLING BULKHEAD WITH REVEMENT

APPLICANT INFORMATION:

OWNER INFORMATION: RICHARD RATHMANN, REAL PROPERTY OWNER
 MARY ANNE RATHMANN, REAL PROPERTY OWNER

PROJECT LOCATION AND INFORMATION:

SITE ADDRESS: 523 HORN POINT DRIVE
 ANNAPOLIS, MD 21403
 MAILING ADDRESS: 523 HORN POINT DRIVE
 ANNAPOLIS, MD 21403
 DISTRICT: 06
 SUBMISSION: 000
 ACCOUNT NUMBER: 05282211
 LOTS: 33 MAP: 052D GRID: 0005 PARCEL: 0742
 DEED REFERENCE: 7/29579 / 00143
 PLAT REFERENCE: B
 PROPERTY LAND AREA: 10,077 S.F. (.23 ACRE)

SHEET TITLE AND DATE:

VICINITY MAP AND AERIAL PHOTO

PROJECT NOTES:

THIS PLAN IS NOT TO BE CONSIDERED A BOUNDARY SURVEY
 RESPECTIVE PARTIES SHOULD PERFORM A PROPERTY BOUNDARY
 SURVEY FOR EXACT DELINEATIONS OF FIELD INTERPRETED DATA
 PROVIDED FOR THIS PERMIT SUBMITTAL.

SEAN WILLIAM LAND STRATEGIES

PO Box 1466
 Annapolis, Maryland 21404

Email: mhb@sean-william.com
 Phone: 202.760.0405

MHC License #137310
 Marine Contractors License #418E
www.seanwilliam.com

EXISTING SITE PLAN

EXISTING CONDITIONS AND DETAILS

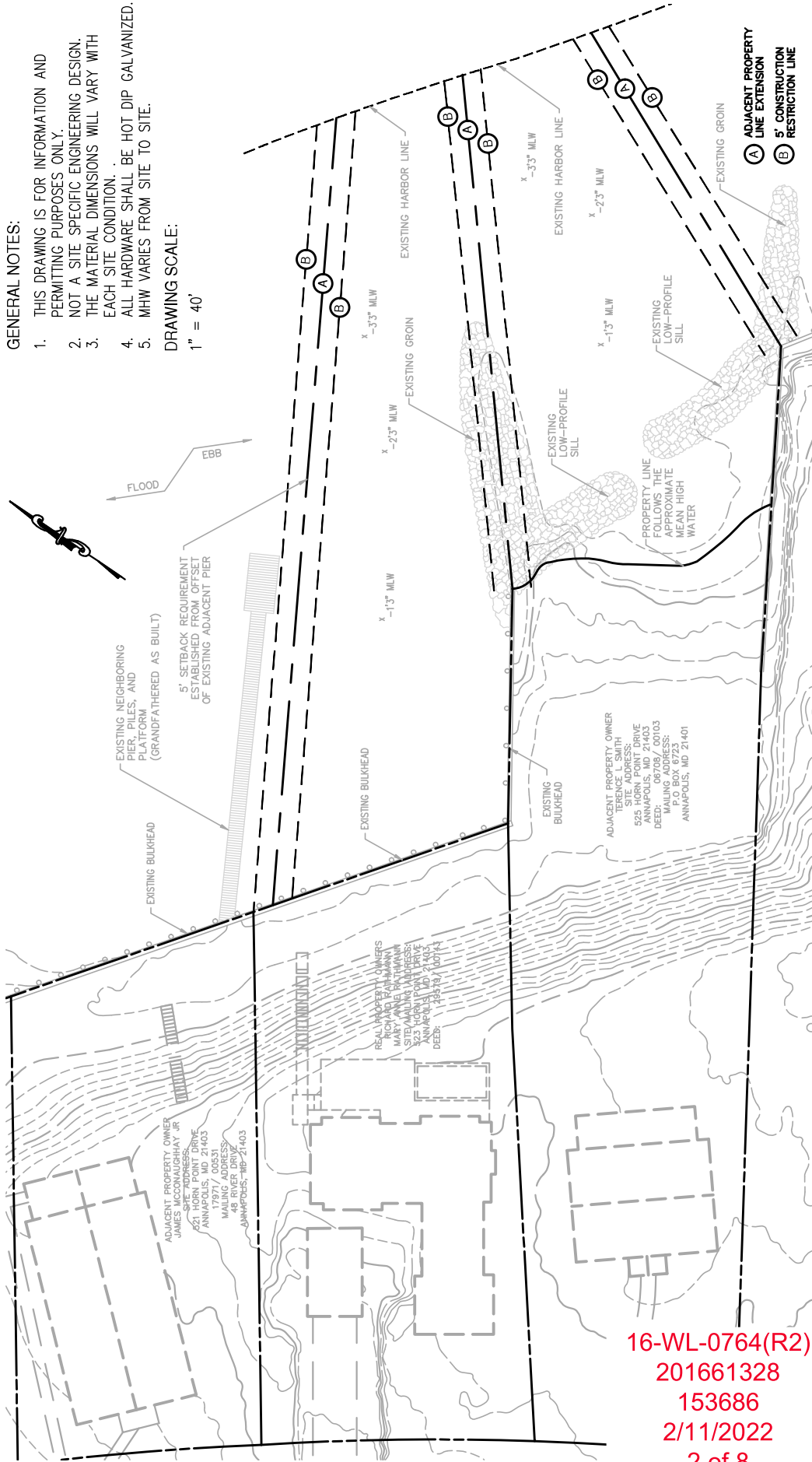

GENERAL NOTES:

1. THIS DRAWING IS FOR INFORMATION AND PERMITTING PURPOSES ONLY.
2. NOT A SITE SPECIFIC ENGINEERING DESIGN. THE MATERIAL DIMENSIONS WILL VARY WITH EACH SITE CONDITION.
3. ALL HARDWARE SHALL BE HOT DIP GALVANIZED.
4. MHW VARIES FROM SITE TO SITE.

DRAWING SCALE:

1" = 40'

16-WL-0764(R2)
201661328
153686
2/11/2022
2 of 8

PROPOSED PROJECT:

- (1) CONSTRUCT 6' X 166' PIER WITH 14' X 135" "L" HEAD
- (2) 3 MOORING PILES WITH 3' X 143" FINGER PIER
- (3) CONSTRUCT 2 BOAT LIFTS, LIFT (1) LIFT BEAMS SPACED 10'-0" APART
- (4) LIFT (2) TO BE ANCHORED TO PIER PILES AND CANTILEVERED
- (5) INSTALLATION OF LIVING SHORELINE WITH SILLS
- (6) REPLACE IN-KIND EXISTING FALLING BULKHEAD WITH REVITMENT

APPLICANT INFORMATION:

RICHARD RATHMANN, REAL PROPERTY OWNER
MARY ANNE RATHMANN, REAL PROPERTY OWNER

PROJECT LOCATION AND INFORMATION:

SITE ADDRESS: 523 HORN POINT DRIVE
ANNAPOLIS, MD 21403
MAILING ADDRESS: 523 HORN POINT DRIVE
ANNAPOLIS, MD 21403
DISTRICT: 06
SUBMISSION: 000
ACCOUNT NUMBER: 05282211
LOTS: 33 MAP: 052D GRID: 0005 PARCEL: 0742
DEED REFERENCE: Z9579 / 00143
PLAT REFERENCE: B
PROPERTY LAND AREA: 10,077 S.F. (.23 ACRE)

SHEET TITLE AND DATE:

EXISTING SITE CONDITIONS AND DETAILS

PROJECT NOTES:

THIS PLAN IS NOT TO BE CONSIDERED A BOUNDARY SURVEY
RESPECTIVE PARTIES SHOULD PERFORM A PROPERTY BOUNDARY
SURVEY FOR EXACT DELINEATIONS OF FIELD INTERPRETED DATA
PROVIDED FOR THIS PERMIT SUBMITTAL.

SEAN WILLIAM LAND STRATEGIES

PO Box 1466
Annapolis, Maryland 21404
Email: info@sean-william.com
Phone: 202.760.0405

MHC License #137310
Marine Contractors License #418E
www.seanwilliam.com

PROPOSED SITE PLAN

PROPOSED CONDITIONS AND DETAILS

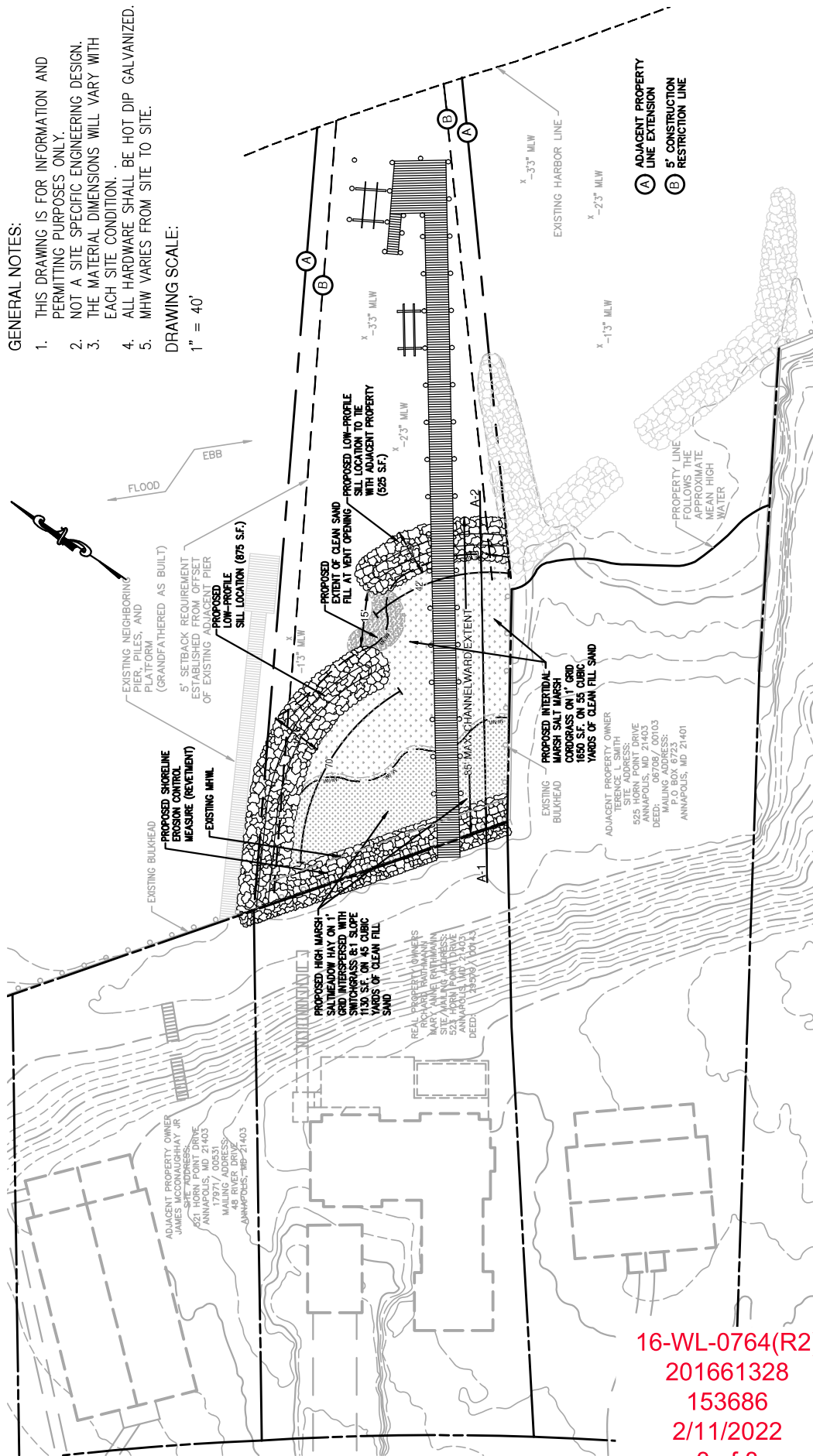

GENERAL NOTES:

- THIS DRAWING IS FOR INFORMATION AND PERMITTING PURPOSES ONLY.
- NOT A SITE SPECIFIC ENGINEERING DESIGN. THE MATERIAL DIMENSIONS WILL VARY WITH EACH SITE CONDITION.
- ALL HARDWARE SHALL BE HOT DIP GALVANIZED. MHW VARIES FROM SITE TO SITE.

DRAWING SCALE:
1" = 40'

16-WL-0764(R2)
 201661328
 153686
 2/11/2022
 3 of 8

<p>PROPOSED PROJECT:</p> <ol style="list-style-type: none"> CONSTRUCT 6' X 166' PIER WITH 14' X 135" "L" HEAD 3 MOORING PILES WITH 3' X 143" FINGER PIER CONSTRUCT 2 BOAT LIFTS, LIFT (1) LIFT BEAMS SPACED 10'-0" APART LIFT (2) TO BE ANCHORED TO PIER PILES AND CANTILEVERED INSTALLATION OF LIVING SHORELINE WITH SILLS REPLACE IN-KIND EXISTING FALLING BULKHEAD WITH REVETMENT <p>APPLICANT INFORMATION: RICHARD RATHMANN, REAL PROPERTY OWNER MARY ANNE RATHMANN, REAL PROPERTY OWNER</p>	<p>PROJECT LOCATION AND INFORMATION:</p> <p>SITE ADDRESS: 523 HORN POINT DRIVE ANNAPOLIS, MD 21403</p> <p>MAILING ADDRESS: 523 HORN POINT DRIVE ANNAPOLIS, MD 21403</p> <p>DISTRICT: 06</p> <p>SUBMISSION: 000</p> <p>ACCOUNT NUMBER: 05282211</p> <p>LOTS: 33. MAP: 052D. GRID: 0005. PARCEL: 0742</p> <p>DEED REFERENCE: 79579 / 00143</p> <p>PLAT REFERENCE: B</p> <p>PROPERTY LAND AREA: 10,077 S.F. (.23 ACRE)</p>	<p>SHEET TITLE AND DATE:</p> <p>PROPOSED SITE CONDITIONS AND DETAILS</p> <p>PROJECT NOTES:</p> <p>THIS PLAN IS NOT TO BE CONSIDERED A BOUNDARY SURVEY. RESPECTIVE PARTIES SHOULD PERFORM A PROPERTY BOUNDARY SURVEY FOR EXACT DELINEATIONS OF FIELD INTERPRETED DATA PROVIDED FOR THIS PERMIT SUBMITTAL.</p>	<p>SHEET TITLE AND DATE:</p> <p>PROPOSED SITE CONDITIONS AND DETAILS</p>	<p>SEAN WILLIAM LAND STRATEGIES</p> <p>PO Box 1466 Annapolis, Maryland 21404</p> <p>Email: info@sean-william.com Phone: 202.760.0405</p> <p>MHC License #137310 Marine Contractors License #418E www.seanwilliam.com</p>	<p>SHEET: 3 OF 8</p>
--	--	--	---	---	----------------------

CONSTRUCTION PLAN

NEW STONE REVETMENT SECTION AT EXISTING BULKHEAD FOR STABILIZATION

GENERAL NOTES:

1. THIS DRAWING IS FOR INFORMATION AND PERMITTING PURPOSES ONLY.
2. NOT A SITE SPECIFIC ENGINEERING DESIGN.
3. THE MATERIAL DIMENSIONS WILL VARY WITH EACH SITE CONDITION.
4. DRAWING NOT TO SCALE

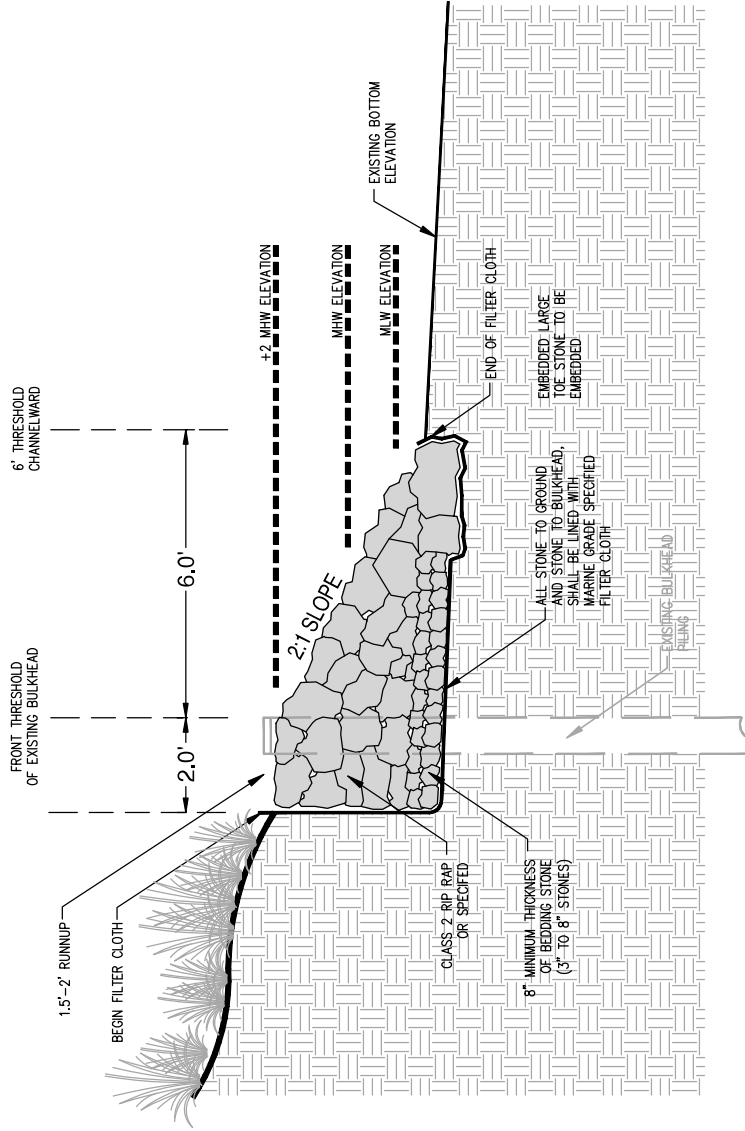

16-WL-0764(R2)
201661328
153686
2/11/2022
4 of 8

PROPOSED PROJECT:

- (1) CONSTRUCT 6' X 166" PIER WITH 14' X 135" "L" HEAD
- (2) 3 MOORING PILES WITH 3' X 143" FINGER PIER
- (3) CONSTRUCT 2 BOAT LIFTS, LIFT (1) LIFT BEAMS SPACED 10'-0" APART
- (4) LIFT (2) TO BE ANCHORED TO PIER PILES AND CANTILEVERED
- (5) INSTALLATION OF LIVING SHORELINE WITH SILLS
- (6) REPLACE IN-KIND EXISTING FALLING BULKHEAD WITH REVETMENT

APPLICANT INFORMATION:

OWNER INFORMATION: RICHARD RATHMANN, REAL PROPERTY OWNER
MARY ANNE RATHMANN, REAL PROPERTY OWNER

PROJECT LOCATION AND INFORMATION:

SITE ADDRESS: 523 HORN POINT DRIVE
ANNAPOLIS, MD 21403
MAILING ADDRESS: 523 HORN POINT DRIVE
ANNAPOLIS, MD 21403
DISTRICT: 06
SUBMISSION: 000
ACCOUNT NUMBER: 05282211
LOTS: 33 MAP: 052D GRID: 0005 PARCEL: 0742
DEED REFERENCE: Z9579 / 00143
PLAT REFERENCE: B
PROPERTY LAND AREA: 10,077 S.F. (.23 ACRE)

SHEET TITLE AND DATE:

CONSTRUCTION PLAN - NEW STONE REVETMENT AT EXISTING BULKHEAD

PROJECT NOTES:

THIS PLAN IS NOT TO BE CONSIDERED A BOUNDARY SURVEY
RESPECTIVE PARTIES SHOULD PERFORM A PROPERTY BOUNDARY
SURVEY FOR EXACT DELINEATIONS OF FIELD INTERPRETED DATA
PROVIDED FOR THIS PERMIT SUBMITTAL.

SEAN WILLIAM LAND STRATEGIES

PO Box 1466
Annapolis, Maryland 21404
Email: info@sean-william.com
Phone: 202.760.0405

MHC License #137310
Marine Contractors License #418E
www.seanwilliam.com

CONSTRUCTION PLAN

TYPICAL PIER, WALKWAY, PLATFORM, AND PILE SPECIFICATIONS

GENERAL NOTES:

1. THIS DRAWING IS FOR INFORMATION AND PERMITTING PURPOSES ONLY.
2. NOT A SITE SPECIFIC ENGINEERING DESIGN.
3. THE MATERIAL DIMENSIONS WILL VARY WITH EACH SITE CONDITION.
4. DRAWING NOT TO SCALE.
5. ALL HARDWARE SHALL BE HOT DIP GALVANIZED.
6. MHW VARIES FROM SITE TO SITE.

TRIMMING DETAIL 1:

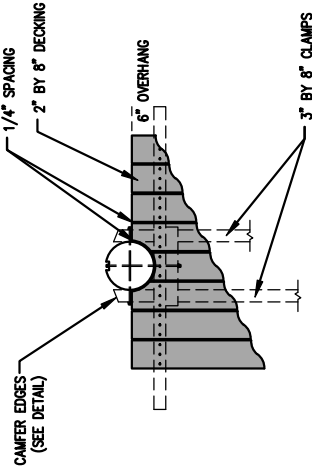

TRIMMING DETAIL 2:

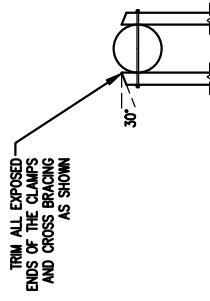

16-WL-0764(R2)
201661328
153686
2/11/2022
5 of 8

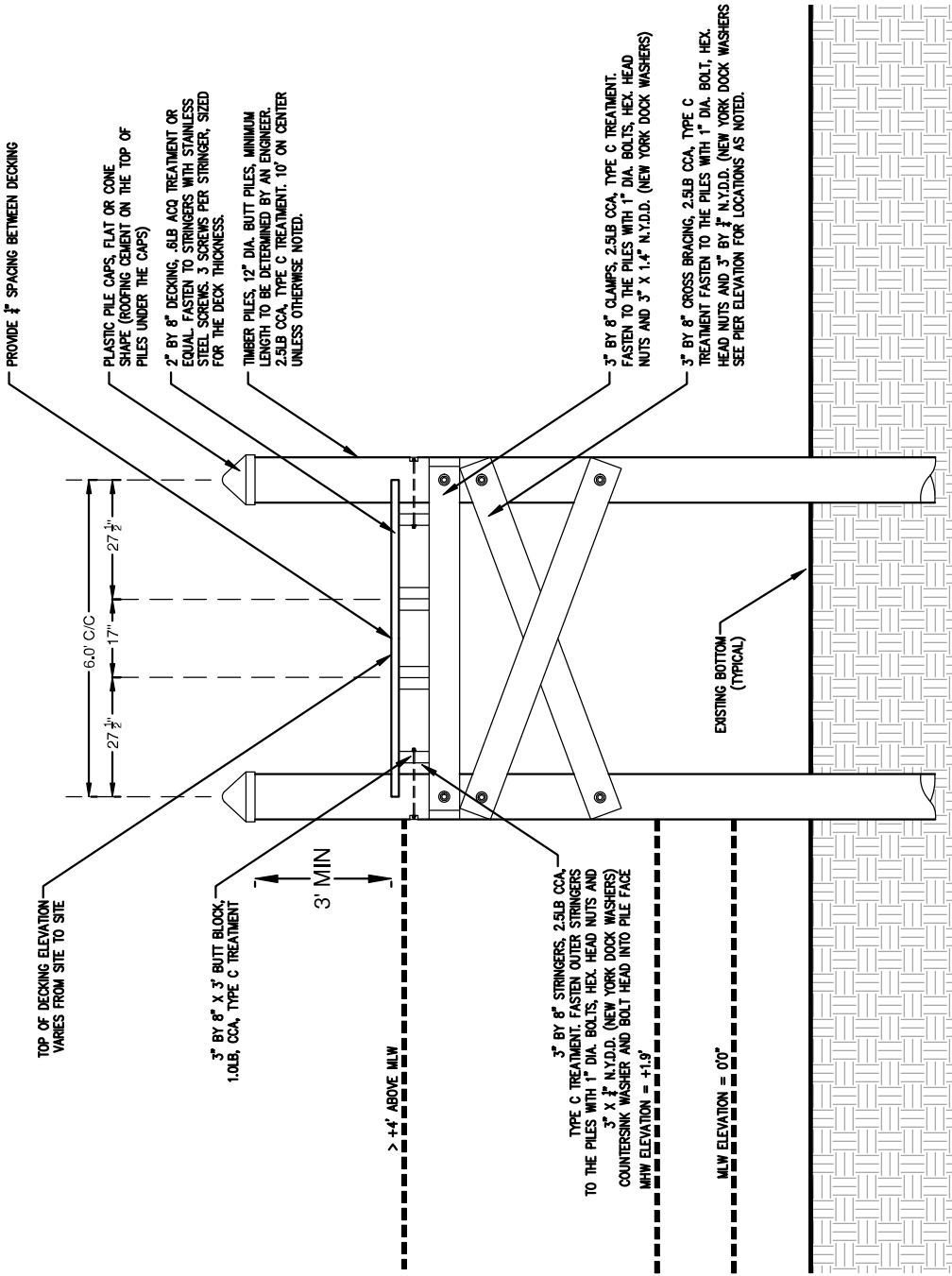

PROPOSED PROJECT:

- (1) CONSTRUCT 6' X 166" PIER WITH 14' X 135" "L" HEAD
- (2) 3 MOORING PILES WITH 3' X 143" FINGER PIER
- (3) CONSTRUCT 2 BOAT LIFTS, LIFT (1) LIFT BEAMS SPACED 10'-0" APART
- (4) LIFT (2) TO BE ANCHORED TO PIER PILES AND CANTILEVERED
- (5) INSTALLATION OF LIVING SHORELINE WITH SILLS
- (6) REPLACE IN-KIND EXISTING FALLING BULKHEAD WITH REVITEMENT

APPLICANT INFORMATION:

OWNER INFORMATION: RICHARD RATHMANN, REAL PROPERTY OWNER
MARY ANNE RATHMANN, REAL PROPERTY OWNER

PROJECT LOCATION AND INFORMATION:

SITE ADDRESS: 523 HORN POINT DRIVE
ANNAPOLIS, MD 21403

MAILING ADDRESS: 523 HORN POINT DRIVE
ANNAPOLIS, MD 21403

DISTRICT: 06

SUBMISSION: 000

ACCOUNT NUMBER: 05282211

LOTS: 33 MAP: 052D GRID: 0005 PARCEL: 0742

DEED REFERENCE: Z9579 / 00143

PLAT REFERENCE: B

PROPERTY LAND AREA: 10,077 S.F. (.23 ACRE)

SHEET TITLE AND DATE:

CONSTRUCTION PLAN - TYPICAL PIER, WALKWAY, PLATFORM,
AND PILE SPECIFICATIONS

PROJECT NOTES:

THIS PLAN IS NOT TO BE CONSIDERED A BOUNDARY SURVEY
RESPECTIVE PARTIES SHOULD PERFORM A PROPERTY BOUNDARY
SURVEY FOR EXACT DELINEATIONS OF FIELD INTERPRETED DATA
PROVIDED FOR THIS PERMIT SUBMITTAL.

SEAN WILLIAM LAND STRATEGIES

PO Box 1466
Annapolis, Maryland 21404

Email: mhb@sean-william.com
Phone: 202.760.0405

MHC License #137310
Marine Contractors License #418E
www.seanwilliam.com

CONSTRUCTION PLAN

CROSS SECTION FOR LIVING SHORELINE

PROJECT NOTES:

1. MAXIMUM CHANNELWARD DISTANCE OF 85' AS SHOWN ON SECTION A-1 TO A-2 ON SITE PLAN
2. 100 CUBIC YARDS OF CLEAN SAND FILL AS SPECIFIED ON PROPOSED CONDITIONS
3. INTERTIDAL MARSH CREATING SALT MARSH CORDGRASS ON 1' GRID
4. HIGH MARSH PLANTING SALTMEADOW HAY ON 1' GRID INTERSPERSED WITH SWITCHGRASS
5. ALL EQUIPMENT AND MATERIALS BY WATER ACCESS ONLY
6. PLANTING TO OCCUR BETWEEN APRIL 1 AND JUNE 30 OR BETWEEN SEPTEMBER 1 AND OCTOBER 30
7. PLANT ON 1' ON CENTER WITH ADDITION OF LOW NITROGEN, SLOW RELEASE FERTILIZER
8. REGULAR WATERING PROGRAM TO BE ESTABLISHED, AS NECESSARY
9. PLANTING AREA TO BE MONITORED FOR TWO YEARS FROM PLANTING DATE
10. A COVERAGE OF 85% MUST BE MAINTAINED; REPLACE AS REQUIRED TO MAINTAIN

GENERAL NOTES:

1. THIS DRAWING IS FOR INFORMATION AND PERMITTING PURPOSES ONLY.
2. NOT A SITE SPECIFIC ENGINEERING DESIGN.
3. THE MATERIAL DIMENSIONS WILL VARY WITH EACH SITE CONDITION.
4. DRAWING NOT TO SCALE.
5. ALL HARDWARE SHALL BE HOT DIP GALVANIZED.
6. MHW VARIES FROM SITE TO SITE.

A-1

A-2

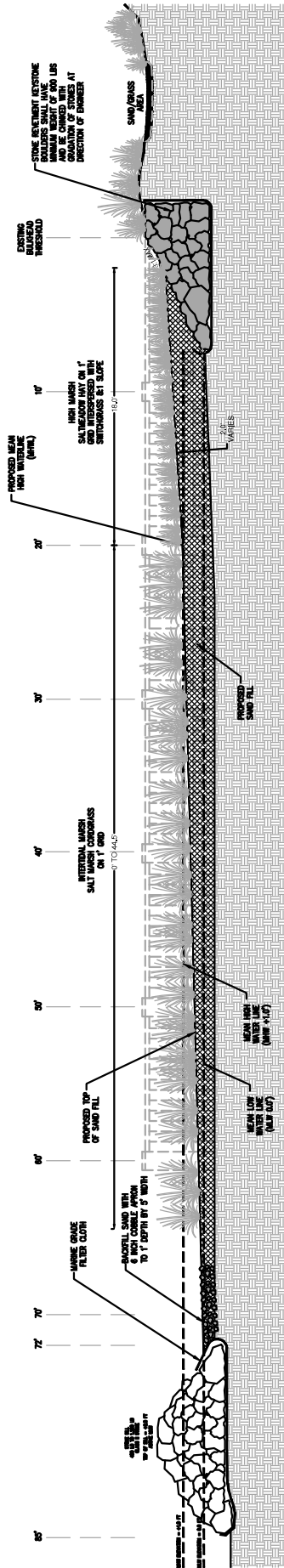

16-WL-0764(R2)
201661328
153686
2/11/2022
6 of 8

PROPOSED PROJECT:

- (1) CONSTRUCT 6' X 166' PIER WITH 14' X 135" "L" HEAD
- (2) 3 MOORING PILES WITH 3' X 143" FINGER PIER
- (3) CONSTRUCT 2 BOAT LIFTS, LIFT (1) LIFT BEAMS SPACED 10'-0" APART
- (4) LIFT (2) TO BE ANCHORED TO PIER PILES AND CANTILEVERED
- (5) INSTALLATION OF LIVING SHORELINE WITH SILLS
- (6) REPLACE IN-KIND EXISTING FALLING BULKHEAD WITH REVITEMENT

APPLICANT INFORMATION:

OWNER INFORMATION: RICHARD RATHMANN, REAL PROPERTY OWNER
MARY ANNE RATHMANN, REAL PROPERTY OWNER

PROJECT LOCATION AND INFORMATION:

SITE ADDRESS: 523 HORN POINT DRIVE
ANNAPOLIS, MD 21403
MAILING ADDRESS: 523 HORN POINT DRIVE
ANNAPOLIS, MD 21403
DISTRICT: 06
SUBMISSION: 000
ACCOUNT NUMBER: 05282211
LOTS: 33 MAP: 052D GRID: 0005 PARCEL: 0742
DEED REFERENCE: Z9579 / 00143
PLAT REFERENCE: B
PROPERTY LAND AREA: 10,077 S.F. (.23 ACRE)

SHEET TITLE AND DATE:

CROSS SECTION FOR LIVING SHORELINE

PROJECT NOTES:

THIS PLAN IS NOT TO BE CONSIDERED A BOUNDARY SURVEY
RESPECTIVE PARTIES SHOULD PERFORM A PROPERTY BOUNDARY
SURVEY FOR EXACT DELINEATIONS OF FIELD INTERPRETED DATA
PROVIDED FOR THIS PERMIT SUBMITTAL.

SEAN WILLIAM LAND STRATEGIES

PO Box 1466
Annapolis, Maryland 21404

Email: info@sean-william.com
Phone: 202.760.0405

MHC License #137310
Marine Contractors License #418E
www.seanwilliam.com

CONSTRUCTION PLAN

CROSS SECTION FOR SILL

PROJECT NOTES:

1. MAXIMUM CHANNELWARD DISTANCE OF 85' AS SHOWN ON SECTION A-1 TO A-2 ON SITE PLAN
2. 100 CUBIC YARDS OF CLEAN SAND FILL AS SPECIFIED ON PROPOSED CONDITIONS
3. INTERTIDAL MARSH CREATING SALT MARSH CORDGRASS ON 1' GRID
4. HIGH MARSH PLANTING SALTMEADOW HAY ON 1' GRID INTERSPERSED WITH SWITCHGRASS
5. ALL EQUIPMENT AND MATERIALS BY WATER ACCESS ONLY
6. PLANTING TO OCCUR BETWEEN APRIL 1 AND JUNE 30 OR BETWEEN SEPTEMBER 1 AND OCTOBER 30
7. PLANT ON 1' ON CENTER WITH ADDITION OF LOW NITROGEN, SLOW RELEASE FERTILIZER
8. REGULAR WATERING PROGRAM TO BE ESTABLISHED, AS NECESSARY
9. PLANTING AREA TO BE MONITORED FOR TWO YEARS FROM PLANTING DATE
10. A COVERAGE OF 85% MUST BE MAINTAINED; REPLACE AS REQUIRED TO MAINTAIN

GENERAL NOTES:

1. THIS DRAWING IS FOR INFORMATION AND PERMITTING PURPOSES ONLY.
2. NOT A SITE SPECIFIC ENGINEERING DESIGN.
3. THE MATERIAL DIMENSIONS WILL VARY WITH EACH SITE CONDITION.
4. DRAWING NOT TO SCALE.
5. ALL HARDWARE SHALL BE HOT DIP GALVANIZED.
6. MHW VARIES FROM SITE TO SITE.

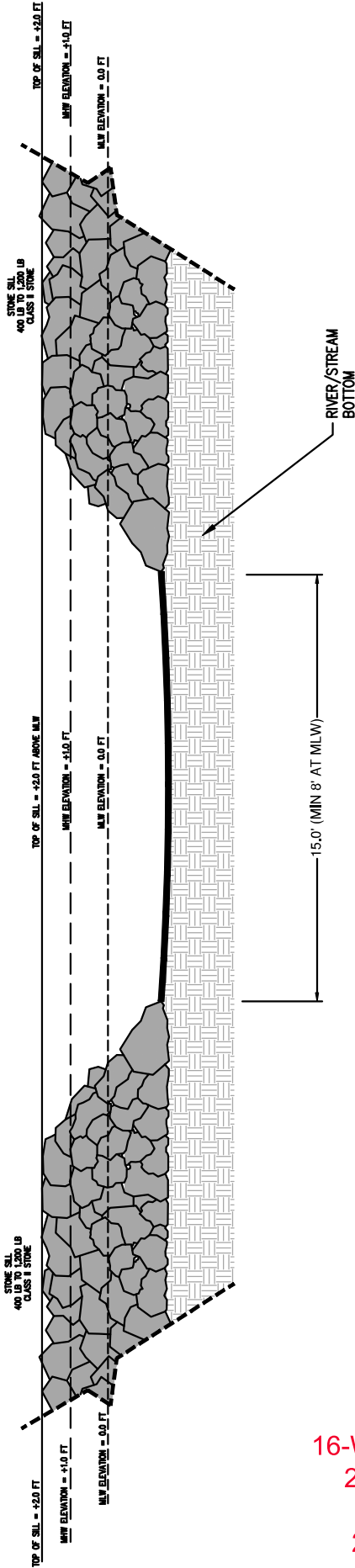

16-WL-0764(R2)
201661328
153686
2/11/2022
7 of 8

PROPOSED PROJECT:

- (1) CONSTRUCT 6' X 166' PIER WITH 14' X 135" "L" HEAD
- (2) 3 MOORING PILES WITH 3' X 143" FINGER PIER
- (3) CONSTRUCT 2 BOAT LIFTS, LIFT (1) LIFT BEAMS SPACED 10'-0" APART
- (4) LIFT (2) TO BE ANCHORED TO PIER PILES AND CANTILEVERED
- (5) INSTALLATION OF LIVING SHORELINE WITH SILLS
- (6) REPLACE IN-KIND EXISTING FALLING BULKHEAD WITH REVITMENT

APPLICANT INFORMATION:

OWNER INFORMATION: RICHARD RATHMANN, REAL PROPERTY OWNER
MARY ANNE RATHMANN, REAL PROPERTY OWNER

PROJECT LOCATION AND INFORMATION:

SITE ADDRESS: 523 HORN POINT DRIVE
ANNAPOLIS, MD 21403
MAILING ADDRESS: 523 HORN POINT DRIVE
ANNAPOLIS, MD 21403
DISTRICT: 06
SUBMISSION: 000
ACCOUNT NUMBER: 05282211
LOTS: 33 MAP: 052D GRID: 0005 PARCEL: 0742
DEED REFERENCE: Z9579 / 00143
PLAT REFERENCE: B
PROPERTY LAND AREA: 10,077 S.F. (.23 ACRE)

SHEET TITLE AND DATE:

CROSS SECTION FOR SILL

PROJECT NOTES:

THIS PLAN IS NOT TO BE CONSIDERED A BOUNDARY SURVEY
RESPECTIVE PARTIES SHOULD PERFORM A PROPERTY BOUNDARY
SURVEY FOR EXACT DELINEATIONS OF FIELD INTERPRETED DATA
PROVIDED FOR THIS PERMIT SUBMITTAL.

SEAN WILLIAM LAND STRATEGIES

PO Box 1466
Annapolis, Maryland 21404

Email: mhb@sean-william.com
Phone: 202.760.0405

MHC License #137310
Marine Contractors License #418E
www.seanwilliam.com

GENERAL NOTES

SITE INFORMATION:

- GENERAL DESCRIPTION OF PREDOMINANT SOIL TYPE AS SHOWN ON USDA NATURAL RESOURCES CONSERVATION SERVICE MAP.
AUB – ANNAPOLIS-URBAN LAND COMPLEX, 0 TO 5% SLOPES, HSG "C"
- EXISTING ZONING IS R2-NC/JDA – RESIDENTIAL DISTRICT SETBACKS:
ESTABLISHED FRONT BRL = 27.5'
ESTABLISHED REAR BRL = 52'
SIDE BRL = 6'
- TOTAL PROPERTY SITE AREA: 10,455 SQUARE FEET OR 0.240 ACRES
- CRITICAL AREA OVERLAY = IDA (INTENSELY DEVELOPED AREA)
- THE PROPERTY DESCRIBED HEREON IS LOCATED IN THE FLOOD HAZARD ZONE "X" (AREA OUTSIDE THE 0.2% ANNUAL CHANCE FLOODPLAIN) AS DELINEATED ON THE FIRM FLOOD INSURANCE MAP #24003C0158F DATED FEBRUARY 18, 2015 FOR SAID COUNTY AND DISTURBED BY THE FEDERAL EMERGENCY MANAGEMENT AGENCY.

NOTES:

- PROPERTY LINES SHOWN HEREON HAVE BEEN TAKEN FROM FIELD EVIDENCE, AND/OR AVAILABLE DEEDS AND/OR PLATS AND SHOULD NOT BE CONSTRUED TO BE REPRESENTATIVE OF THE ACCURACY OF A BOUNDARY SURVEY. THIS PLAN SET IS NOT A BOUNDARY SURVEY. THESE PLAN SETS WERE DEVELOPED WITHOUT THE BENEFIT OF A TITLE SEARCH AND MAY NOT REFLECT ENCUMBRANCES, DEDICATIONS, AND/OR RESTRICTIONS WHICH MAY EXIST AND COULD POTENTIALLY BE REVEALED THROUGH A COMPREHENSIVE TITLE EXAMINATION.
- ALL WORK SHALL BE PERFORMED FROM WATER WITH BARGE ALONG THE EXISTING SHORELINE WITHIN THE L.O.D. TO THE SHORELINE AS SHOWN AND ALL WORK SHALL BE CONFINED TO THE SUBJECT PROPERTY.
- CONTRACTOR IS RESPONSIBLE FOR THE LOCATION OF ANY PROPOSED STRUCTURES IN RELATION WITH THE PROPERTY CORNERS. NEIGHBORING STRUCTURES SHOWN ON THIS DRAWING ARE APPROXIMATE IN LOCATION AND SHOULD NOT BE USED TO LOCATE ANY NEW STRUCTURES. A SURVEY IS REQUIRED TO LOCATE ANY NEW OR REPLACEMENT STRUCTURES. THIS SURVEY MUST BE PERFORMED BY A STATE OF MARYLAND LICENSED SURVEYOR.
- THIS SITE PLAN HAS BEEN PREPARED TO REQUEST A MODIFICATION TO REPLACE A BULKHEAD WITH A REVETMENT AND ALTER A PRIOR APPROVED SILL LOCATION. ANY CHANGE TO THESE PLANS WILL REQUIRE A SEPARATE PERMIT FROM ANNE ARUNDEL CO., AND IF WORK IS WITHIN THE WATER OR SHORELINE; MARYLAND DEPARTMENT OF THE ENVIRONMENT AND THE ARMY CORPS OF ENGINEERS. THIS WILL REQUIRE MORE DETAILS AND INFORMATION AND THIS DRAWING SHALL NOT BE UTILIZED FOR SUCH LICENSES OR PERMITS.
- CONTACT MISS UTILITY AT LEAST 10 DAYS PRIOR TO START OF ANY ON LAND OR IN WATER WORK. ALL UTILITIES MUST BE LOCATED PRIOR TO ANY CONSTRUCTION. THIS PLAN SHALL NOT BE UTILIZED FOR LOCATING ANY UTILITIES EITHER ABOVE AND/OR BELOW GROUND.
- TOPOGRAPHY WAS OBTAINED FROM THE ANNE ARUNDEL COUNTY DEPARTMENT OF PUBLIC WORKS GIS TOPOGRAPHY. VERTICAL DATUM IS 0.0 FEET IS EQUAL TO MEAN LOW WATERLINE.
- WATER DEPTHS WERE OBTAINED FROM FIELD MEASUREMENTS AND HAVE A DATUM OF 0.0' OR MEAN LOW WATERLINE.
- THE CONTRACTOR MUST FIELD VERIFY ALL QUANTITIES AND MEASUREMENTS TO THEIR SATISFACTION. THESE SITE PLANS ARE FOR PERMIT PURPOSES ONLY AND SHALL NOT BE UTILIZED FOR CONSTRUCTION PURPOSES OTHER THAN GENERAL LOCATION OF STRUCTURES.

16-WL-0764(R2)
201661328
153686
2/11/2022
8 of 8

PROPOSED PROJECT:

- CONSTRUCT 6' X 166' PIER WITH 14' X 135" "L" HEAD
- 3 MOORING PILES WITH 3' X 143" FINGER PIER
- CONSTRUCT 2 BOAT LIFTS, LIFT (1) LIFT BEAMS SPACED 10'-0" APART
- LIFT (2) TO BE ANCHORED TO PIER PILES AND CANTILEVERED
- INSTALLATION OF LIVING SHORELINE WITH SILLS
- REPLACE IN-KIND EXISTING FALLING BULKHEAD WITH REVETMENT

APPLICANT INFORMATION:

OWNER INFORMATION: RICHARD RATHMANN, REAL PROPERTY OWNER
MARY ANNE RATHMANN, REAL PROPERTY OWNER

PROJECT LOCATION AND INFORMATION:

SITE ADDRESS: 523 HORN POINT DRIVE
ANNAPOLIS, MD 21403
MAILING ADDRESS: 523 HORN POINT DRIVE
ANNAPOLIS, MD 21403
DISTRICT: 06
SUBMISSION: 000
ACCOUNT NUMBER: 05282211
LOTS: 33 MAP: 052D GRID: 0005 PARCEL: 0742
DEED REFERENCE: Z9579 / 00143
PLAT REFERENCE: B
PROPERTY LAND AREA: 10,077 S.F. (.23 ACRE)

SHEET TITLE AND DATE:

GENERAL NOTES

PROJECT NOTES:

THIS PLAN IS NOT TO BE CONSIDERED A BOUNDARY SURVEY. RESPECTIVE PARTIES SHOULD PERFORM A PROPERTY BOUNDARY SURVEY FOR EXACT DELINEATIONS OF FIELD INTERPRETED DATA PROVIDED FOR THIS PERMIT SUBMITTAL.

SEAN WILLIAM LAND STRATEGIES

PO Box 1466
Annapolis, Maryland 21404
Email: info@sean-william.com
Phone: 202.760.0405
MHC License #137310
Marine Contractors License #418E
www.seanwilliam.com